



Detection and Ranging Solutions

Laser measurement technology –
components and application packages

Product family overview

Components	
TIM3xx	D-6
S100	D-10
LMS1xx	D-14
LMS5xx	D-20
LD-OEM	D-26
LD-LRS	D-30
LD-MRS	D-34
Application packages	
JEF3xx	E-4
JEF5xx	E-8
LMC1xx	E-12
LMP	E-16
LMS4xx	E-18
NAV	E-22

Detection

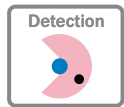

Detection is determining if an object is in the monitored area. The result is either "Object in the monitored area" or "No object in the monitored area" from the sensor's switching outputs.

Ranging



Measurement or ranging describes the relative distance data between object and sensor. If objects are located within the measuring zone, the distance data is output via an interface. The result is positions or coordinates.

Multi-echo technology



Multi-echo is a ground-breaking technology that enables reliable measured values even in adverse weather conditions such as rain, fog or snow. To obtain reliable measurement values and refine object detection, multiple echoes are first received and evaluated from each laser pulse emitted.

Find a suitable detection and ranging solution

			Features	Requirements	Applications				
						Operating range (with 10 % reflectivity)	Field of view		
D	Components	D-6	TIM3xx	●			0.05 m ... 4 m (2 m)	270°	
		D-10	S100	●			0 m ... 10 m (4.5 m)	270°	
		D-14	LMS1xx	●	●	●	0,5 m ... 50 m (18 m)	270°	
		D-20	LMS5xx	●	●	●	0 m ... 80 m (26 m / 40 m)	190°	
		D-26	LD-OEM	●	●		0.5 m ... 250 m (35 m)	360°	
		D-30	LD-LRS	●	●		0.5 m ... 250 m (80 m / 150 m)	360°	
		D-34	LD-MRS	●	●	●	0.5 m ... 250 m (30 m / 50 m)	85°	
E	Application packages	E-12	LMC1xx	●	●		0.5 m ... 20 m (18 m)	270°	
		E-16	LMP	●	●		0 m ... 250 m (depending on type)	180° ... 360°	
		E-18	LMS4xx	●	●		0.7 m ... 3 m (3 m)	70°	
		E-22	NAV		●		0,5 m ... 250 m (28.5 m)	360°	

Legend with link to sample solutions



Area monitoring C-6



Checking presence C-5



Classification C-12



Collision protection C-9



Distance measurement . . . C-7



Height control C-4



Level monitoring C-15



Navigation C-8



Path detection C-11



Position recognition . . . C-10



Shape recognition C-14

General information

About SICK

A

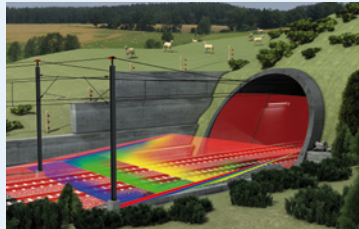

Technologies

B

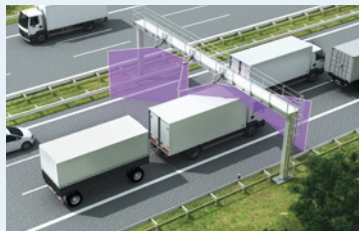

Typical applications

C



Laser measurement technology - components

TiM3xx, S100, LMS1xx, LMS5xx,
LD-OEM, LD-LRS, LD-MRS

D



Laser measurement technology - application packages

JEF3xx, JEF5xx, LMC1xx, LMP, LMS4xx, NAV

E

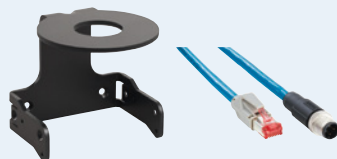

Accessories

F

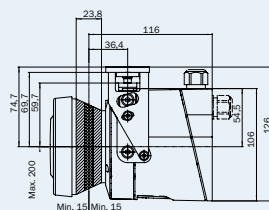

Dimensional drawings

G

Sensor Intelligence is our promise

SICK sensor solutions for industrial automation are the result of exceptional dedication and experience. From development all the way to service: The people at SICK are committed to investing all their expertise in providing with the very best sensors and system solutions possible.

A company with a culture of success

Approximately 5,000 people are on staff, with products and services available to help SICK sensor technology users increase their productivity and reduce their costs. Founded in 1946 and headquartered in Waldkirch, Germany, SICK is a global sensor specialist with more than 50 subsidiaries and representations worldwide. Our exemplary corporate culture

fosters an optimum work-life balance, thus attracting the best employees from all over the world. SICK is one of the best employers – we have been among the winners of the prestigious German “Great Place to Work” award for many years in succession.



Innovation for the leading edge

SICK sensor systems simplify and optimize processes and allow for sustainable production. SICK operates thirteen research and development centers all over the world. Co-designed with customers and universities, our innovative sensor products and solutions are made to give a decisive edge. With an impressive track record of innovation, we take the key parameters of modern production to new levels: reliable process control, safety of people and environmental protection.



A corporate culture for sustainable excellence

SICK is backed by a holistic, homogeneous corporate culture. We are an independent company. And our sensor technology is open to all system environments. The power of innovation has made SICK one of the technology and market leader – sensor technology that is successful in the long term.



A

Sensor Intelligence for all requirements

SICK is a renowned expert in many industries, and is entirely familiar with the critical challenges they face. While speed, accuracy and availability take center stage in all industries, technical implementations vary greatly. SICK puts its vast experience to use to provide with precisely the solution you need.

For applications worldwide

Hundreds of thousands of installations and applications go to prove that SICK knows the different industries and their processes inside out. This tradition of uncompromising expertise is ongoing: As we move into the future, we will continue to design,

implement and optimize customized solutions in our application centers in Europe, Asia and North America. You can count on SICK as a reliable supplier and development partner.

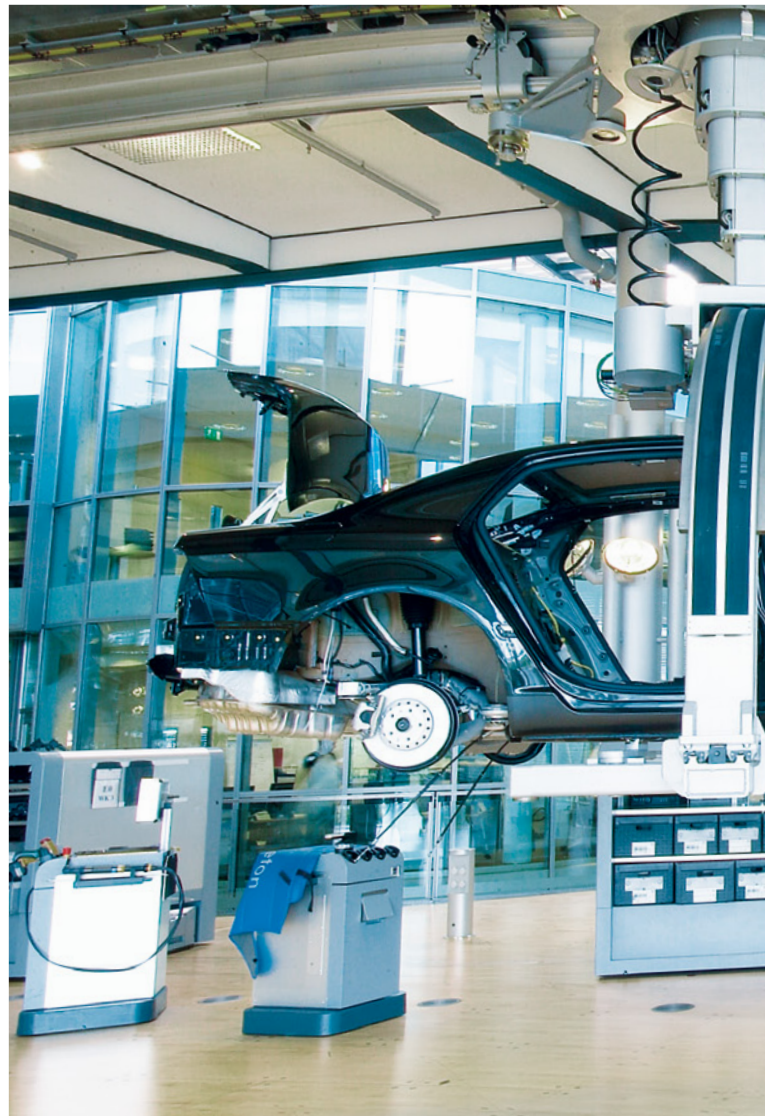
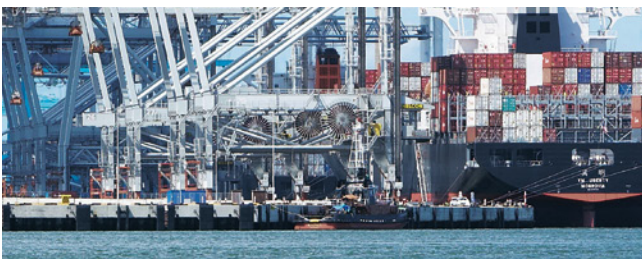

For your specific industry

With a track record of proven expertise in a great variety of industries, SICK has taken quality and productivity to new heights. The automotive, pharmaceutical, electronics and solar industries are just a few examples of sectors that benefit from our know-how. In addition to increasing speed and improving traceability in warehouses and distribution centers, SICK solutions provide accident protection for automated guided vehicles. SICK system solutions for analysis and flow measurement of gases and liquids enable environmental protection and sustainability in, for example, energy production, cement production or waste incineration plants.

For performance across the board

SICK provides the right technology to respond to the tasks involved in industrial automation: measuring, detecting, monitoring and controlling, protecting, networking and integrating, identifying, positioning. Our development and industry experts continually create groundbreaking innovation to solve these tasks.



www.sick.com/Industries



A

For safety and productivity: SICK LifeTime Services

SICK LifeTime Services is a comprehensive set of high-quality services provided to support the entire life cycle of products and applications from system design all the way to upgrades. These services increase the safety of people, boost the productivity of machines and serve as the basis for our customers' sustainable business success.



Benefit from an array of services

Each of our products and solutions is accompanied by a comprehensive range of services tuned precisely to the requirements of the product or solution – along its entire life cycle. Backed by extensive industry know-how and more than sixty

years of experience, LifeTime Services stand for maximum availability and an exceptional service life of our products and solutions.





Training & Education

- User training
- Seminars
- WebTraining



Product & System Support

- Commissioning
- Spare parts and repairs
- Remote support
- Hotline



Verification & Optimization

- Barcode checks
- Consulting/Engineering service
- Inspection
- Maintenance
- Accident analysis
- Stop time measurement
- Noise measurement



Consulting & Design

- System inspection
- Risk assessment
- Safety concepts
- Feasibility studies
- Software and hardware design



Upgrade & Retrofits

- Machine conversion
- Sensor upgrades
- Sensor replacements
- Retrofitting of technology

 www.sick.com/service



A Versatile product range for industrial automation

From the simple acquisition task to the key sensor technology in a complex production process: with every product from its broad portfolio, SICK offers a sensor solution that best combines cost effectiveness and safety.



www.sick.com/products

Industrial sensors



- Photoelectric sensors
- Inductive proximity sensors
- Capacitive proximity sensors
- Magnetic proximity sensors
- Magnetic cylinder sensors

Identification solutions



- Bar code scanners
- Image-based code readers
- Hand-held scanners
- RFID

Detection and ranging solutions



- Laser measurement technology

System solutions



- Volume measurement systems
- Code reading systems
- Dimension weighing scanning systems

Fluid sensors



- Level sensors
- Pressure sensors
- Flow sensors
- Temperature sensors

Registration sensors



- Contrast sensors
- Color sensors
- Luminescence sensors
- Fork sensors
- Array sensors

Distance sensors



- Short range distance sensors (displacement)
- Mid range distance sensors
- Long range distance sensors
- Linear measurement sensors
- Ultrasonic sensors
- Double sheet detector
- Optical data transmission
- Position finders

Automation light grids



- Advanced automation light grids
- Standard automation light grids
- Smart light grids

Vision



- Vision sensors
- Smart cameras
- 3D cameras
- Vision illuminations

Opto-electronic protective devices



- Safety laser scanners
- Safety camera systems
- Safety light curtains
- Multiple light beam safety devices
- Single-beam photoelectric safety switches
- Mirror and device columns
- Outdoor safety systems
- Upgrade kits

Safety switches



- Electro-mechanical safety switches
- Non-contact safety switches
- Safety command devices

sens:Control – safe control solutions



- Safety relays
- Safety controllers
- Network solutions

Motion control sensors

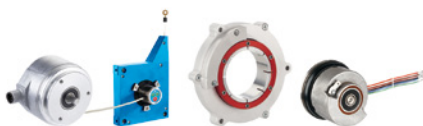

- Motor feedback systems
- Encoders

B



Laser measurement technology

Laser measurement technology provides solutions for a broad range of applications. Two-dimensional or multi-dimensional contour data is captured and processed both externally and internally. The technology is ideal for indoor and outdoor applications such as collision prevention in ports, in-traffic classification, detection for building automation, intrusion monitoring or position evaluation in navigation.



Scanning laser measurement technology

A scanning laser measurement sensor uses one or more sender diodes diverted by a rotating mirror. A single pulse or modulated frequency pulse of the laser diode is spread in a horizontal plane as a distance and reflectivity energy value is determined for each individual point. The single measurements points are accumulated over the field of view to create a full scan plane. SICK offers scanners using pulse or phase time method, operating field of view angles between 70 and 360 degrees and ranging from several meters to several hundred meters.



B

Pulse time method

The distance between sensor and object is calculated by measuring the time interval between emission of the laser pulse and the pulse being received again. The signal received also provides information about the reflectivity of the object.

Multi-echo

Interference factors like rain, fog, snow or dust can influence a sensor's measurements and considerably reduce the usability of the entire system. The latest generation of SICK outdoor laser measurement sensors are designed so that they even work with a higher level of precision and measurement reliability in adverse weather conditions.

In general, one reflection echo is received per emitted laser beam from an object like a rain drop or an obstacle. By receiving several echoes for each emitted laser pulse, detection of objects has been optimized significantly. This technology is also known as the multiple pulse time method.

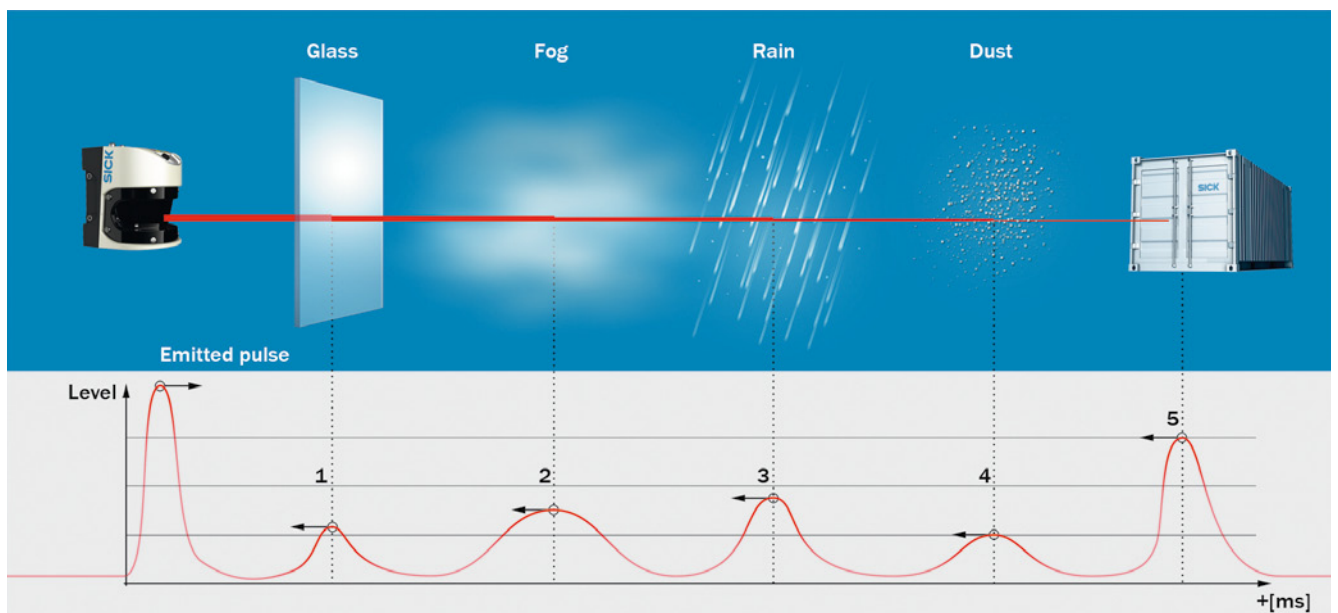

Multiple pulse time method (multi-echo technology) based on the example of the LMS5xx



Multi-layer

Pitching and rolling movements (e.g., of a vehicle) can cause the relevant object to disappear when there is only one measuring plane, even though the object is in the measurement range. Multi-layer technology works with multiple vertically arranged measurement lines, which work in parallel and are emitted simultaneously. Distance measurements are then made independently for each measurement line. With the LD-MRS, for example, four measurement layers are used and the vertical aperture angle is 3.2° . This enables full compensation of any

pitching movements on the part of the vehicle, for example due to ground waves or dynamic driving maneuvers such as braking or acceleration.

Objects and ramps can also be distinguished by means of the four measurement planes while conveyance systems are stopped before relevant obstacles.

In static operation, four measuring planes enable, among other things, reliable area monitoring.

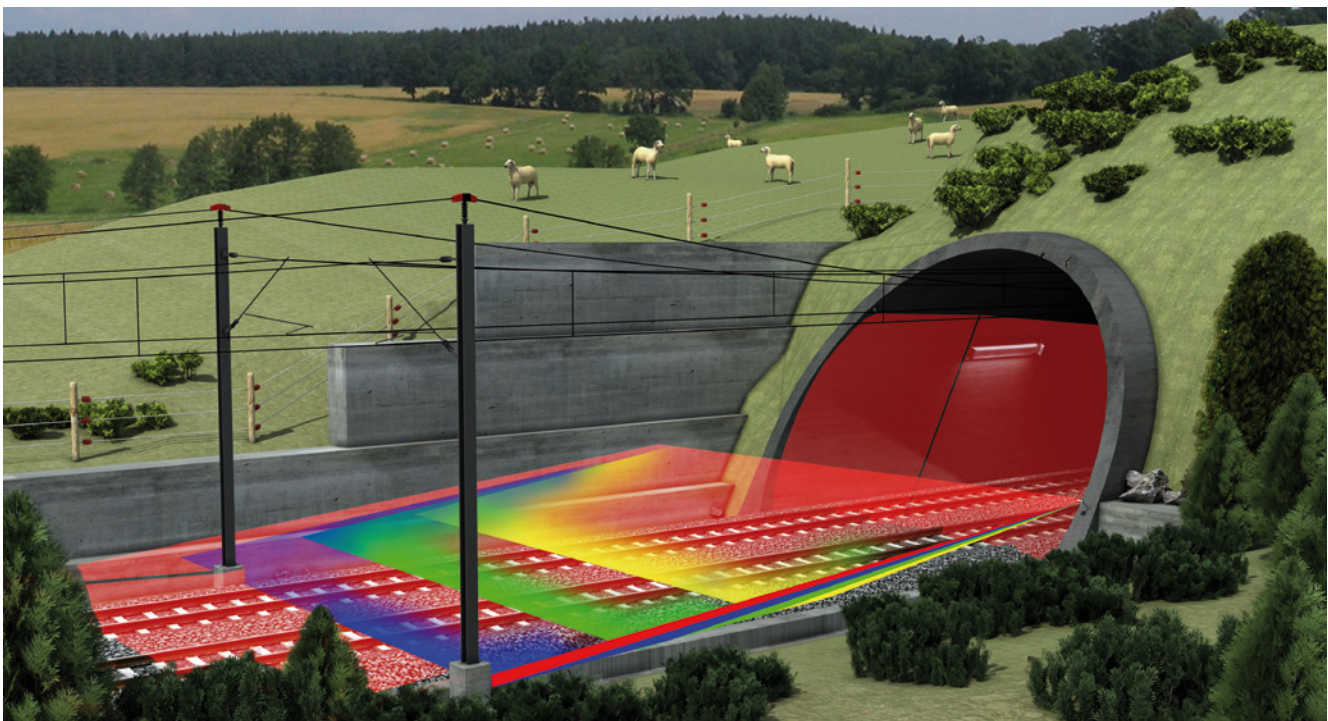

Phase time method

B

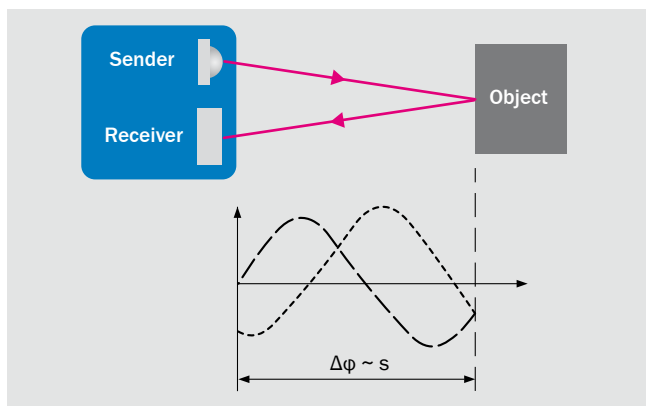

Schematic representation of the phase time method

With a phase time sensor a sine wave is modulated onto the visible laser beam. Distance and reflectivity are measured based on the differences in phase flight time between the outgoing wave and the wave reflected by the object. The optimized phase time method, patented by SICK, enables faster measurement. To do this, a phase and intensification condition is used in a closed resonance cycle.

Measuring environment

Sender/receiver in a single housing

Laser measurement sensors combine the sender and receiver sensing elements in a single housing, providing a compact measuring system that requires less space and installation time compared to other solutions.

Non-light-dependent measurement

By being emitted in the form of a laser pulse, measurements can be made that are independent of ambient light (including in pitch black).

Surfaces/reflectivity

Reflectivity describes the part of the laser pulse that is reflected. Depending on the surface composition (structure, color), each material has its own specific reflectivity. When a laser pulse hits a surface, energy is partly absorbed by the material.

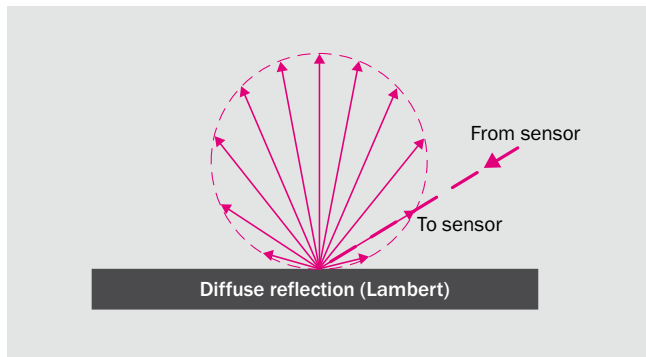
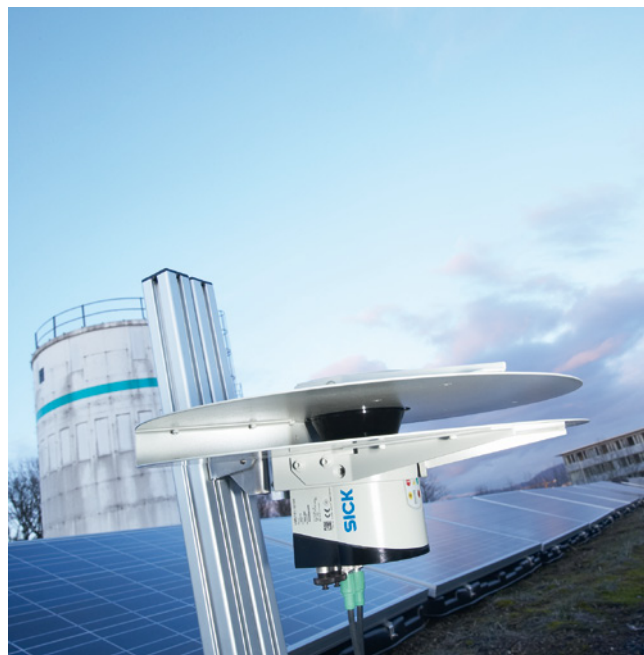

Reflection of a Lambert surface

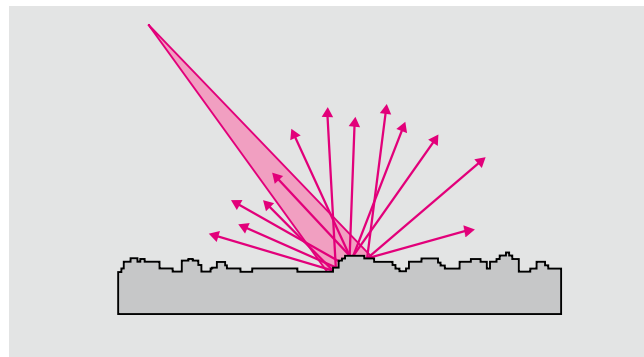

Reflection of a real surface

Scanning range

The scanning range of the sensor depends on the reflectivity of the detected object. The better a surface reflects the beams it is hit by, the greater the range of the sensor will be. Range data for SICK sensors in this catalog are based on 10 % reflectivity; a matte black object.

Spot size and spot spacing

In a scanning laser measurement sensor, a single pulse or modulated frequency pulse of the laser diode is spread in a horizontal plane as a distance and reflectivity energy value is determined for each individual point. In an individual emitted beam, the light spot has a measurable diameter that increases the further it is from the scanner and is described in terms of diameter at the sensor window and radians to describe the shape of the emitted beam. In single pulse scanning laser measurement sensors, it is preferable to have individual beams overlap adjacent beams to improve the sensor's resolution and increase a sensor's ranging and detecting capabilities. Beam separation can be eliminated by ensuring the angle resolution is less than or equal to the beam size. Angle resolution is the angle between individual emitted beams. Angle resolution and beam separation are critical when a measured object becomes smaller or its features are more important.

For an object to be detected reliably, it must be completely hit by a beam once. With partial hits, less energy is reflected by an object than is required in some cases. An object will be hit reliably and fully if it is at least as large as the measuring spot distance plus the beam diameter. For reliable measurement, an object needs to be hit several times. For this reason, an object should either be larger than the minimum object size, or both sensor and object should not move.

Measuring frequency

The measuring frequency is the number of measurements per second in Hertz. With each revolution of the mirror, a scan is made. In multiple or interlaced scan mode, the measurement frequency decreases.

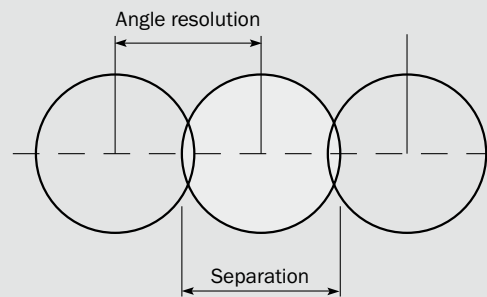

Beam separation/angle resolution

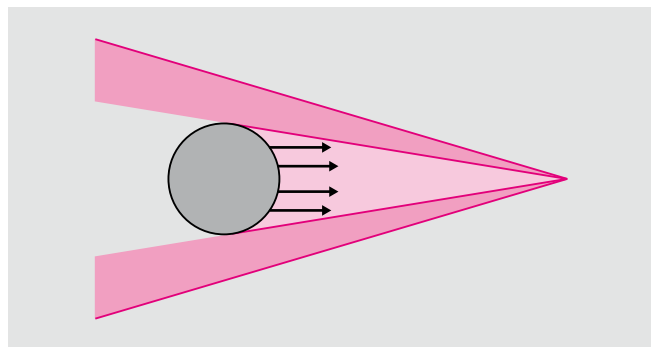

Beam separation/object size

B

Advantages of laser measurement technology

- Suitable for object measurement and positioning, area monitoring and prevention of collisions
- Scanning angle from 70° to 360°
- For both indoor and outdoor use
- No special reflective properties required for measuring objects
- No reflectors or markings required for objects
- Measuring objects can be in any position
- Measured data available in real time
- Mounting positions outside of the collision area
- Reliable monitoring of buildings and objects using flexible design of monitored fields
- Any attachment position
- Low installation costs due to large monitored fields



Typical applications

This chapter describes typical applications for SICK measurement and detection solutions. The detailed descriptions of **applications, tasks, implementation** and **benefits** also contain **further recommendations on products** you can use for your application.

Descriptions in the catalog are categorized by industry sector as follows:

- Automotive
- Beverages
- Building automation
- Metals
- Mobile vehicles
- Ports
- Traffic
- Waste



C

Typical applications

Recommended products for solving applications C-2

Automotive

Height control

Position determination and height control of pallet stacks in a depalletization system C-4

Beverages

Checking presence

Completeness checks with bottle containers C-5

Building automation

Area monitoring/security

Open terrain monitoring (perimeters) C-6

Metals

Distance measurement

Slab measurement and position determination in the rolling mill. C-7

Mobile vehicles

Navigation

Navigation of automated guided vehicles C-8

Ports

Collision protection

Anti-collision tasks in the work area of the crane beam of ship-to-shore cranes. C-9

Ports

Position and layer determination

Automatic detection of container positions and layers with a stacker crane. C-10

Path/angle detection

Driver assistance with stacker cranes C-11

Traffic

Classification

Electronic classification of trucks using laser measurement systems C-12

Identification of vehicles at toll gates C-13

Shape recognition

Contour detection of train blocks in automatic washing systems C-14

Waste

Level monitoring

Fill level detection of bulk materials for control of automatic gripper cranes C-15

Recommended products for solving applications

	TIM3xx	S100	LMS1xx (Indoor)	LMS1xx (Outdoor)	LMS5xx (Indoor)	LMS5xx (Outdoor)	LD-OEM	LD-LRS	LD-MRS	LMC1xx	LMP	LMS4xx	NAV
Automotive													
Height control Position determination and height control of pallet stacks in a depalletization system	■		■		■		■					■	
Beverages													
Checking presence Completeness checks with bottle containers	■	■	■									■	
Building automation													
Area monitoring/security Open terrain monitoring (perimeters)	■			■		■		■	■	■			
Metals													
Distance measurement Slab measurement and position determination in the rolling mill			■	■	■	■	■	■	■				
Mobile vehicles													
Navigation Navigation of automated guided vehicles													■
Ports													
Collision protection Anti-collision tasks in the work area of the crane beam of ship-to-shore cranes				■		■		■			■		
Position and layer determination Automatic detection of container positions and layers with a stacker crane				■		■		■	■				
Path/angle detection Driver assistance with stacker cranes				■		■			■				
Traffic													
Classification Identification of vehicles at toll gates				■		■			■				
Classification Electronic classification of trucks using laser measurement systems				■		■							
Shape recognition Contour detection of train blocks in automatic washing systems			■	■	■	■						■	
Waste													
Level monitoring Fill level detection of bulk materials for control of automatic gripper cranes				■		■	■	■				■	
From page	D-6	D-10	D-14	D-14	D-20	D-20	D-26	D-30	D-34	E-12	E-16	E-18	E-22

C

Detection



Detection may be described as the recognition of an object in the scanning field, which may have almost any outer limit. Output is to the sensor's switching output, the result of which is an "object in field" or "object not in field" statement.

For detection, additional refined evaluations can be performed depending on the laser measurement sensor type.

Level control, for instance, is evaluated within a field. This enables customers to define columns of any width in a specified rectangular field. Within these columns, an output for full or empty may occur by a switching threshold that is set via a user-defined switching output. This is a simple method where a large number of individual sensors or a flexible setup are required to handle quickly the application.

For anti-collision tasks, using of sensors with several measuring planes compensates for pitching and inclination during braking and acceleration maneuvers. The sensor, therefore, always has an unrestricted view of the path and reliably reports any possible collisions to the switching outputs.

Ranging

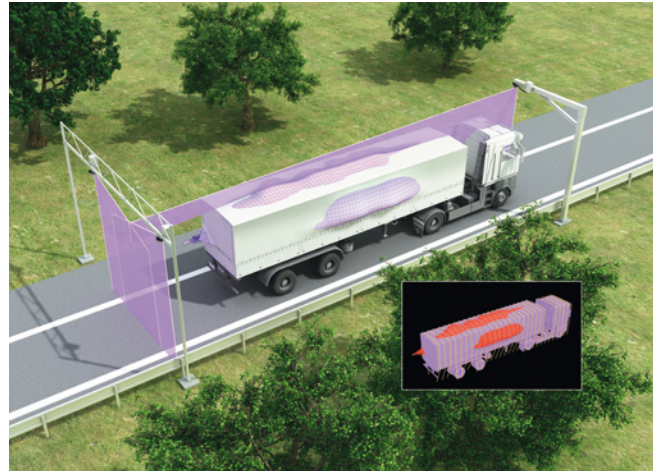

The identification of an object position within the scanning field of a sensor is known as measuring or ranging.

If object positions are located in the scanning field, the exact positional value is output at the interface.

This results in positional and coordinate values in a digital output format that is capable of being read by machines.

The output of distance data as polar coordinates with distance and angle is a standard function of laser measurement sensors. Furthermore, energy content of the returning signal is output as an echo value. Selectable filters can improve the measuring result in the applications. The measured data forms a precise image of the scan plane and movement of the object or sensors enables the host system to create 3D evaluation of the environment.

When level control is used, height values can be determined according to the fill level of the column and then output. This enables evaluations in external systems or a PLC.

Sensors that are used for navigation of AGVs/AGSs output reflector positions as data. Depending on the desired specifications, direct positional data for the sensor and for direction of movement are also output. This is then evaluated by the vehicle's navigation computers.

Multi-layer sensors have the advantage that, when used as measuring sensors, a 3D map of the environment can be output in a certain field of vision. As a result, measuring data can be detected in a 3D scan.

C

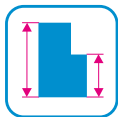

Applications  Finder

- For up-to-date application solutions, visit SICK's web site
→ www.mysick.com/applications
- The "Applications Finder" will lead you to further solutions that use SICK products

Position determination and height control of pallet stacks in a depalletization system

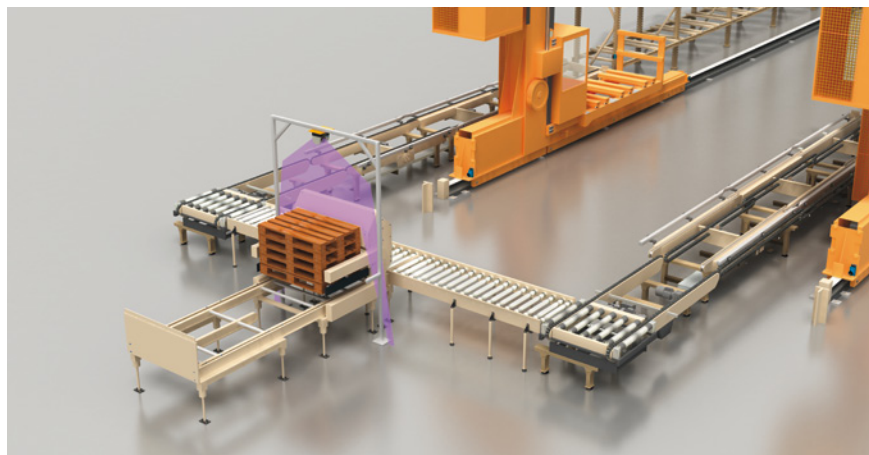

Concise description

The laser measurement sensor detects the position and height of pallet stacks

with various load carriers for automatic depalletization.

Task

In an automotive plant, a conveyor belt is used to ensure continuous warehouse and production supply. For this application, the goal is to increase the capacity of the conveyor belt between the incoming goods and the high-bay warehouse.

To do this, automatic depalletization of pallet stacks up to 3 m high – comprising various load carriers – was required. A dual-lane depalletization system is used that removes individual load carriers from the bottom.

Implementation

For each lane, a laser measurement sensor is used to detect the position of pallets and monitor the height of the relevant pallet stack. Contour and position of several different load carriers are taught in. The only common feature for all pallets is the pallet foot, which is normed as per DIN 15155 and can be detected and checked by the relevant laser measurement sensor. Potential interference factors, such as a soiled foot or skewed pallet stacks, have no effect on the measurement. The stacks of pallets to be placed in storage reach the depalletizer in a random order and have a random stacking pattern.

After capturing the contour of a pallet foot, the positional tolerance is checked. Once the positional tolerance is determined the laser measurement sensor is moved up to check the stack height. The stack is then lifted up, the lowest pallet removed by a chain conveyor and conveyed toward the high-bay warehouse. The pallet stack is set down again, the position of the new bottom pallet is checked and the height of the remaining stack is redetermined. When the last pallet has been reached and moved out of the depalletizer, the next pallet stack can be fed in.

Customer benefits

The overall system has a high level of reliability due to the laser measurement sensors. This makes it possible

to considerably increase the conveying capacity.

Recommended products

TiM3xx	D-6
LMS1xx (Indoor)	D-14
LMS5xx (Indoor)	D-20
LD-OEM	D-26
JEF3xx	E-4
JEF5xx	E-8
LMS4xx	E-18

C

Completeness checks with bottle containers

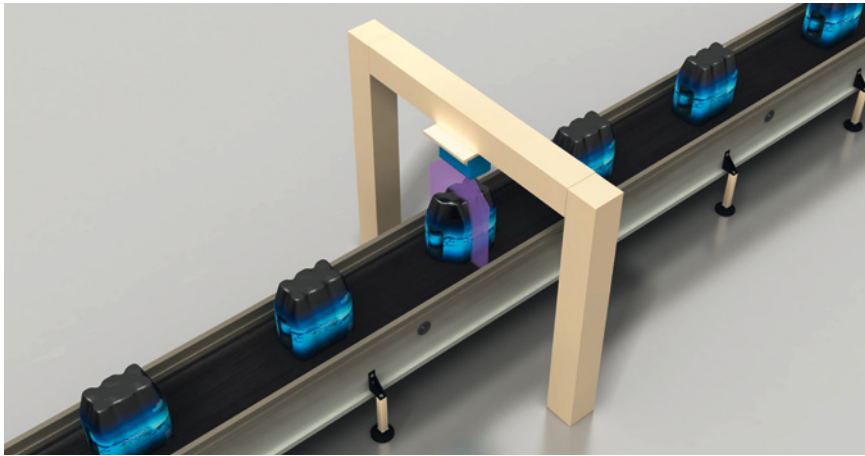

Concise description

Three-dimensional presence and position checking with bottle containers using

laser measurement sensors such as the LMS400.

Task

Up to 70,000 half-liter bottles are filled per hour in large beer filling plants. These systems are also ideal for other bottle sizes due to fast technical changeover. After filling, the bottles are packed

into the container and then conveyed for palletization. However, before palletization, the container must be checked to ensure the correct number of bottles are present.

Implementation

The contour of the container and the crown caps is determined three-dimensionally due to reflectivity of the fanned laser beam emitted by the laser measurement sensor over the containers. Positional and distance data is available in milliseconds. If a bottle is missing or if it is incor-

rectly positioned, an evaluation program triggers ejection of the container. In addition, the sensor can easily identify bottles of different sizes for quick and easy changeover. The modified heights, widths and lengths can be detected without changing any mechanical components or control software.

Customer benefits

Quality control prior to palletization means returns of entire batches can be avoided. Cycle times for the plant are also significantly increased due to rapid detection of containers. The sensor is highly

resistant to external interference such as shiny surfaces or indirect, external light sources. The high level of reliability and enhanced cycle time increases the economic viability of the entire plant.



Applications Finder

- For up-to-date application solutions, visit SICK's web site
→ www.mysick.com/applications
- The "Applications Finder" will lead you to further solutions that use SICK products

Other applications

- Checking for projections in logistics warehouses
- Checking for projections with small parts
- Checking for empty with transport crates
- Detecting and checking of removal access with a manual small parts bay
- Monitoring removal of correct component from warehouse bays during final assembly

Recommended products

TIM3xx	D-6
S100	D-10
LMS1xx (Indoor)	D-14
JEF3xx	E-4
JEF5xx	E-8
LMS4xx	E-18



Applications  Finder

- For up-to-date application solutions, visit SICK's web site
→ www.mysick.com/applications
- The "Applications Finder" will lead you to further solutions that use SICK products

Other applications

- Protecting paintings in an art gallery
- Counting people in a shopping center
- Camera tracking for building security

Recommended products

TiM3xx	D-6
LMS1xx (Outdoor)	D-14
LMS5xx (Outdoor)	D-20
LD-LRS	D-30
LD-MRS	D-34
LMC1xx	E-12

Open terrain monitoring (perimeters)

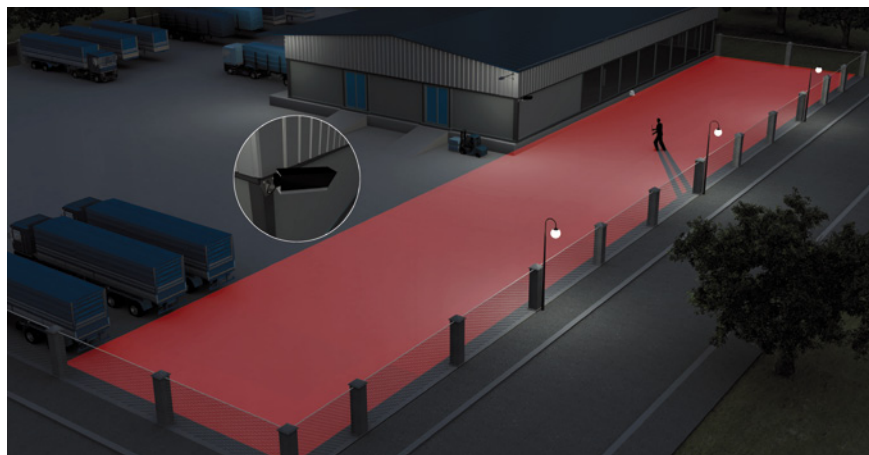

Concise description

In outdoor applications, a high level of reliability due to a low Rate of Undesirable Messages (RUM) is a key assessment factor. With external and open terrain protection (perimeters) from theft and

vandalism, laser measurement technology has proven to be not only an economical alternative to CCTV (Closed Circuit Television), but also an enhancement.

Task

In this application, objects and persons need to be detected reliably regardless of weather, light, size or composition.

The system must be tamper-proof to be able to set alarm messages via floating relay outputs.

Implementation

An actively scanning laser measurement sensor is a non-contact, two-dimensional detection system that detects persons whether it's day or night. High ranges of up to 300 m can be reliably monitored – even in adverse ambient conditions like rain or snow. Freely configurable, monitored fields enable precise setting

and prevent false alarms. Laser measurement sensors are simple to mount and maintain. They can also be used for outdoor facade and roof protection and camera control or for indoor use in industry, public utilities or private households.

Customer benefits

- Systems are certified by the VdS or German technical testing authority, ensuring reliable monitoring
- Industrial design and multi-echo technology guarantee a high level of reliability
- Flexibly configurable monitored fields
- eliminate the need for mechanical barriers
- Space-saving mounting and OPC interface enable simple retrofitting
- Incident-controlled detection supports video sensors, reducing alarm verification measures

C

Slab measurement and position determination in the rolling mill

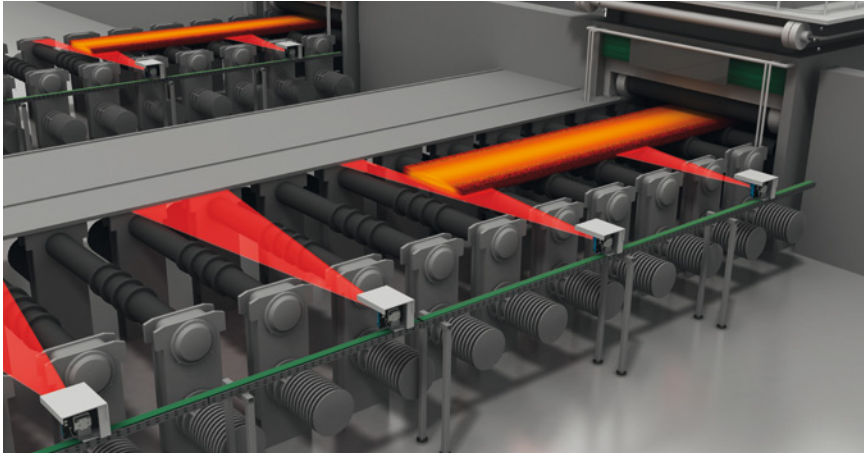

Concise description

Laser measurement sensors are used in a rolling mill to determine the position of slabs in the machining process. Data is

used for assignment and for decisions on subsequent processing.

Task

In a hot rolling mill plant, the goal is to determine the exact position, width and number of slabs so that the data can be

forwarded to a higher-level warehouse management system.

Implementation

A measuring system with two laser measurement sensors is used to capture data. An integrated PC processes this

data and then forwards it to the warehouse management system via Ethernet.

Customer benefits

Using the laser measurement sensors, all types of beams with various temperatures are captured and their position in the processing and warehousing process

is determined. This leads to optimization of the production process and process optimization for higher throughput in the plant.

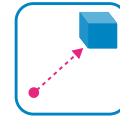

Applications Finder

- For up-to-date application solutions, visit SICK's web site
→ www.mysick.com/applications
- The "Applications Finder" will lead you to further solutions that use SICK products

Other applications

- Measurement of shaft caverns
- Mobile measurement of track and tunnel systems
- Taxiing aircraft into parking position and triggering the stop command
- Precise, cost-efficient laser surveying of railroad lines and tunnels

C

Recommended products

LMS1xx	D-14
LMS5xx	D-20
LD-OEM	D-26
LD-LRS	D-30
LD-MRS	D-34



Applications  Finder

- For up-to-date application solutions, visit SICK's web site
→ www.mysick.com/applications
- The "Applications Finder" will lead you to further solutions that use SICK products

Other applications

- Anti-collision tasks in an automotive paint shop
- Navigation of mobile, autonomous service robots for a wide range of applications
- Navigation of mobile, autonomous monitoring robots for detection of hazards and persons
- Control and roadway monitoring of autonomous passenger vehicles
- Control of a mobile monitoring robot using a laser measurement system

Recommended products

NAV..... E-22

Navigation of automated guided vehicles

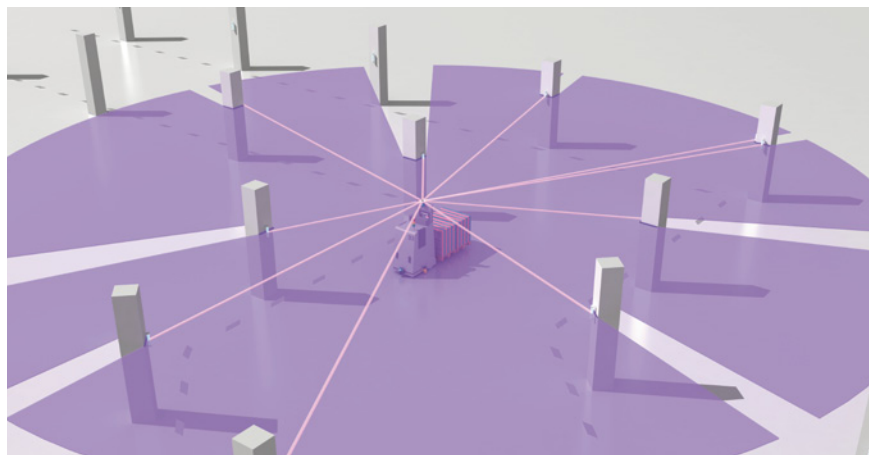

Concise description

Automated guided vehicles (AGVs) work using odometry, i. e., position determination based on data from the drive system (such as number of wheel rotations). Due to error characteristics, such as unevenness in the ground and inaccuracies in driving geometry, the AGV may deviate from the path. Using NAV laser-assisted positioning sensors, however, such errors can be corrected and the AGV kept on its path.

The principle of operation for NAV sensors is the same as for an optical radar. With their 360-degree perspective, they capture reflector marks within a working environment and measure distance and direction with a high level of precision. In addition, NAV sensors calculate their own absolute position and report this back to the on-board computer. The on-board computer then corrects any deviation to the AGV's path.

Task

An automated guided vehicle needs to be kept on a specified, preprogrammed path.

Interference factors due to odometry mean the AGV's deviations from the path need to be corrected.

Implementation

By mounting a NAV sensor on the AGV and installing reflectors within the working environment, reflector marks are detected and their distance and direction is

measured with a high level of precision. The precise position of the AGV within the area is determined and the path is calculated.

C

Anti-collision tasks in the work area of the crane beam of ship-to-shore cranes



Concise description

A laser-based measurement sensor prevents a ship-to-shore crane from colliding with a floating bridge or its equipment

fittings by using warning and protection zones.

Task

A ship-to-shore crane unloads containers from a ship. When doing this, there is a danger that it will collide with the floating bridge, which may be higher than the container stacks. Additional equipment

such as antennas may also be fitted to the bridge. Crane operators therefore need to receive both a warning signal, if they are too close to the bridge, and a stop signal, if a collision is likely.

Implementation

In this application, a laser measurement sensor is mounted on the horizontal crane beam and equipped with warning and stopping zones. If the crane is too close to the bridge, the sensor will first

give the command to slow down via the warning zone. If it gets dangerously close, a signal will be output via the stopping zone to the control and the crane will be stopped.

Customer benefits

Dangerous collisions with high levels of damage can be avoided.

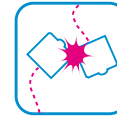

Applications Finder

- For up-to-date application solutions, visit SICK's web site
→ www.mysick.com/applications
- The "Applications Finder" will lead you to further solutions that use SICK products

Other applications

- Anti-collision tasks for transport of materials with pallet cage storage
- Protection of a manned electrical suspension conveyor
- Collision prevention in an automotive paint shop
- Detection of obstacles on the tracks in underground stations
- Detection of ships and lock control in the Panama Canal
- Roadway monitoring of moving trucks
- Course monitoring of autonomous rail vehicles
- Crashless handling of containers

Recommended products

LMS1xx (Outdoor)	D-14
LMS5xx (Outdoor)	D-20
LD-LRS	D-30
LMP	E-16

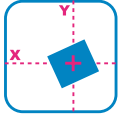

Applications Finder

- For up-to-date application solutions, visit SICK's web site
→ www.mysick.com/applications
- The "Applications Finder" will lead you to further solutions that use SICK products

Other applications

- Control of a robot for depalletization of crates
- Positioning of the gripper of a loading/unloading robot
- Control of a fully-automatic packaging robot
- Depalletizing pistons in the automotive supplier industry
- Automatic handling of animals for slaughter by robots
- 3D layer detection using laser measurement system
- 3D contour detection of wheel rims

Recommended products

LMS1xx (Outdoor)	D-14
LMS5xx (Outdoor)	D-20
LD-LRS	D-30
LD-MRS	D-34

Automatic detection of container positions and layers with a stacker crane

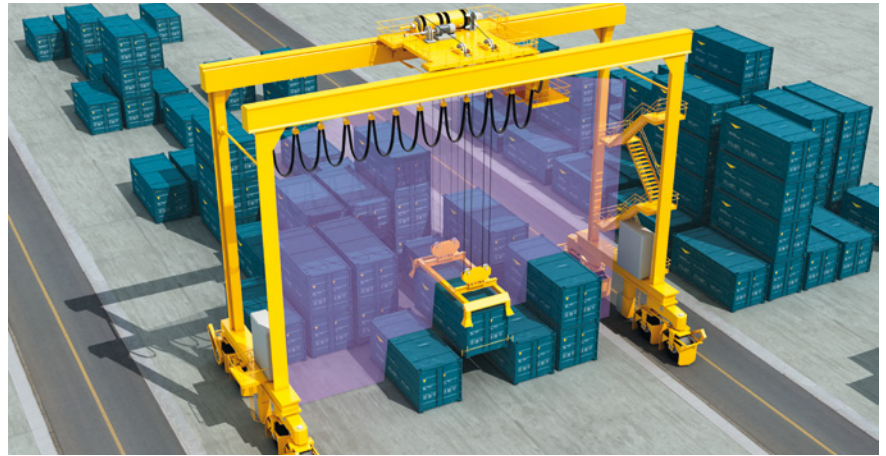

Concise description

Layers and positions of containers need to be determined in the stacking area. Position determination enables the

stacker crane to automatically grip the container so it can be picked up or set down on existing containers.

Task

When containers are picked up or set down with a driverless stacker crane, the position and layer of containers needs to be determined so that they are set down precisely on top of one another and, when picked up, the top containers

are gripped by the spreader first. As a result, laser measurement sensors are mounted above the spreader. They scan the contours of the container's surface and forward the positions to the controlling computer, which controls the crane.

Implementation

Laser measurement sensors act as a technical eye in this application. The sensor is mounted on the overhead gantry crane and moved using a turning unit. A 3D image of the scene below is generated. Using this scene, the integrator obtains the necessary information so that, among other things, the contours of

the existing containers can be extracted. This enables the container to be set down or picked up. Ground reflectors can also be used for absolute referencing. Detection of the reflectors and distinction from the environment are simple due to evaluation of the echo values from the distance measurement.

Customer benefits

24/7 use of the crane is possible due to automatic detection of positions. Picking performance is enhanced overall.

More effective use of the storage bay and a higher throughput enable a more economical operation.

C

Driver assistance with stacker cranes



Concise description

When Rubber Tired Gantry cranes (RTGs) are driving at different speeds, the crane operator may not have a clear view of the entire roadway. For this reason, the

roadway must be monitored and a signal must be transmitted to the crane operator when an obstacle crosses the lane of traffic.

Task

In container ports, RTGs transport containers from the stacking area to the warehouse, and from the warehouse to the transfer area. They also transport containers to trucks. The crane operators do not always have a clear view of the roadway, which may be crossed by people or by other vehicles. Incorrectly placed containers might also be located

in the lane of traffic. The RTG must sometimes turn corners, and may be driven at greatly varying speeds (up to 130 m/min.). For this reason, a solution was needed to convey a signal to the operator in the event that the roadway was blocked by an obstacle. This solution needed to be effective at varying crane speeds and while turning corners.

Implementation

The laser measurement sensor is mounted on the lower side of each crane shoe. The two scan fields are then adjusted to the speed so that the scan field is small at low speeds and then increases as the vehicle speed increases. This allows the

sensor to recognize obstacles quicker and send a message to the operator indicating whether the person or object is located in the first or second scan field so that the operator can slow down or stop.

Customer benefits

Dynamic adaptation of the scan fields makes the crane safer to operate at high speeds and provides the operator with more time to react to obstacles. The

sensors are incredibly durable and insensitive to dirt and soiling, which reduces maintenance costs and downtime for the RTGs.



Applications Finder

- For up-to-date application solutions, visit SICK's web site
→ www.mysick.com/applications
- The "Applications Finder" will lead you to further solutions that use SICK products

Other applications

- Laser measurement systems enable crane visibility guidance for automatic coil loading

C

Recommended products

LMS1xx (Outdoor)	D-14
LMS5xx (Outdoor)	D-20
LD-MRS	D-34



Applications  Finder

- For up-to-date application solutions, visit SICK's web site
→ www.mysick.com/applications
- The "Applications Finder" will lead you to further solutions that use SICK products

Electronic classification of trucks using laser measurement systems

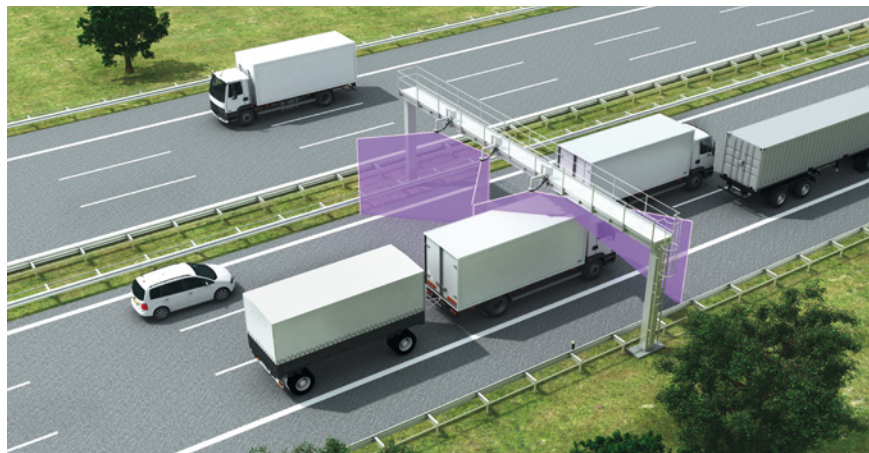

Concise description

With section-based tolls, LMS laser measurement sensors ensure reliable

detection and billing-optimized detection of all vehicles during moving traffic.

Task

The goal is to identify people who dodge paying tolls. To reduce this problem, stationary control equipment is used to

check if passing vehicles are liable for tolls.

Implementation

Depending on the roadway width, several LMS are installed on a gantry that spans the roadway. On evaluation of measured data, information is generated that uniquely identifies vehicles. This is done using the length, width and height of towing vehicles and trailers or semitrailers as well as via a characteristic profile of the vehicle.

If a vehicle is detected that is liable for a toll, it is captured in 3D using additional sensors in a special process. The image is so detailed that the weight class, number of axles, vehicle type, etc., are determined. At the same time, cameras capture the license plate and other details.

Customer benefits

The outdoor housing, the reliable scanning process – not dependent of daylight or surface – and the software algorithms for suppressing interference allow the LMS to operate in adverse conditions.

Highly accurate results are provided regardless of the speed of trucks. Toll dodgers are reliably detected and a fine can then be imposed on offenders.

Recommended products

LMS1xx (Outdoor)D-14

LMS5xx (Outdoor)D-20

C

Identification of vehicles at toll gates

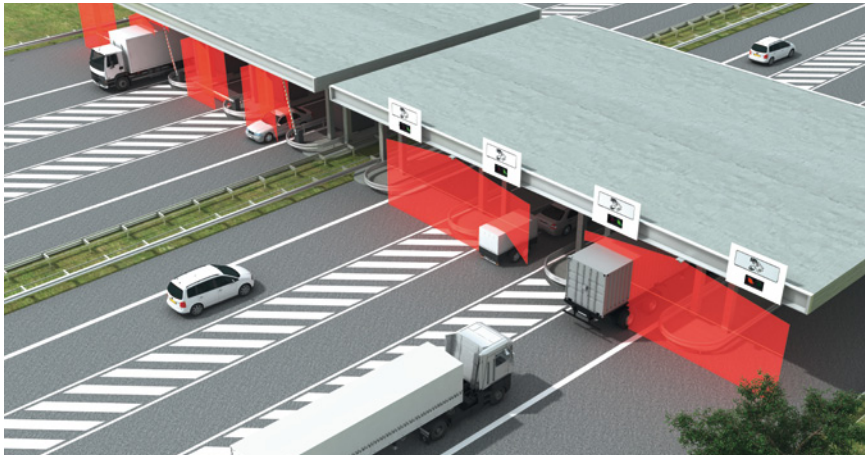

Concise description

Vehicles of various sizes need to be captured at tollgates on highways so that the toll fee can be determined. The subsequent payment process is fully

automatic. Vehicles are classified using laser measurement sensors. One sensor is also able to monitor two lanes.

Task

A reliable system was sought for detecting vehicles of varying heights and lengths, such as passenger cars, trucks or camper

vans with and without a trailer. Vehicles are classified according to height.

Implementation

Laser measurement sensors offer the perfect solution. Mounted above entrances to the customs area, these sensors scan the vehicle vertically using laser fans. Two lanes can be monitored in parallel at a scanning angle of up to 270°, which is

a huge benefit since height data for two vehicles can be determined and forwarded simultaneously. Laser measurement sensors are highly resistant to environmental influences and insensitive to dirt.

Customer benefits

The possibility of monitoring two lanes simultaneously significantly lowers mounting time when compared with other solutions such as light grids. Attachment above the roadway protects the sensors

from destruction and soiling compared to light grids that are mounted at the side. The sensor's industrial housing also saves a great deal of maintenance work.



Applications Finder

- For up-to-date application solutions, visit SICK's web site
→ www.mysick.com/applications
- The "Applications Finder" will lead you to further solutions that use SICK products

Other applications

- Vehicle body identification and status monitoring using laser measurement
- Traffic data capturing using a laser measurement system
- Classifying vehicles
- Electronically classifying trucks using laser measurement sensors
- Classifying aircraft and determining of the angle of rotation of the nose wheel

C

Recommended products

LMS1xx (Outdoor)	D-14
LMS5xx (Outdoor)	D-20
LD-MRS	D-34



Applications  Finder

- For up-to-date application solutions, visit SICK's web site
→ www.mysick.com/applications
- The "Applications Finder" will lead you to further solutions that use SICK products

Other applications

- Three-dimensional measurement of steel bundles, including knot detection

Contour detection of train blocks in automatic washing systems

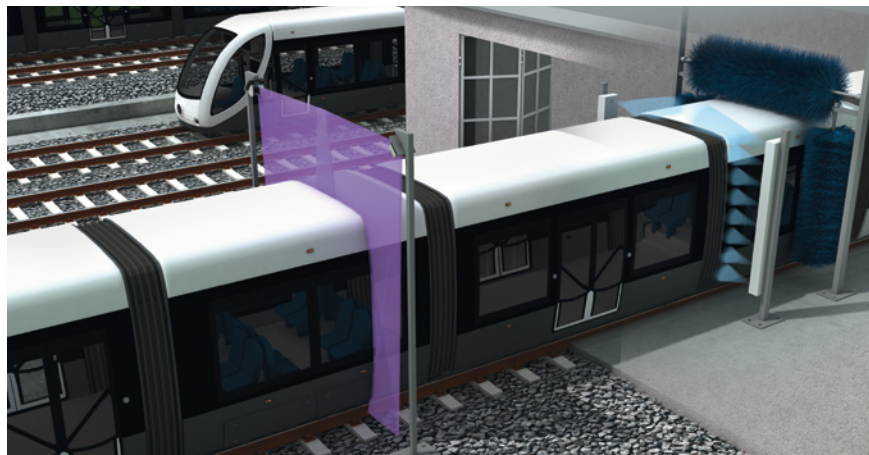

Concise description

Laser measurement sensors enable efficient and environmentally friendly, external cleaning of block trains in automatic washing systems.

Task

A company has developed washing systems for block trains that are several hundred meters long. A measuring system was sought for contour detection to detect any open doors or service hatches as well as damage/destruction of trains or prevent damage to the expensive washer brushes.

Implementation

Laser measurement sensors determine the contour of the train, carry out a check of the external shell and distinguish between engine and carriage. Using this information, a suitable washing program is then determined for the block train. Due to laser measurement, 3D-controlled washing brushes can be moved precisely along the train's contour.

Customer benefits

Automatic cleaning of block trains and individual engines and carriages is possible using the washing gantry. Damage is prevented by the exterior shell check. In addition, washing and cleaning agents can be used sparingly or in environmentally friendly processes.

Recommended products

- LMS1xx D-14
- LMS5xx D-20
- LMS4xx E-18

C

Fill level detection of bulk materials for control of automatic gripper cranes

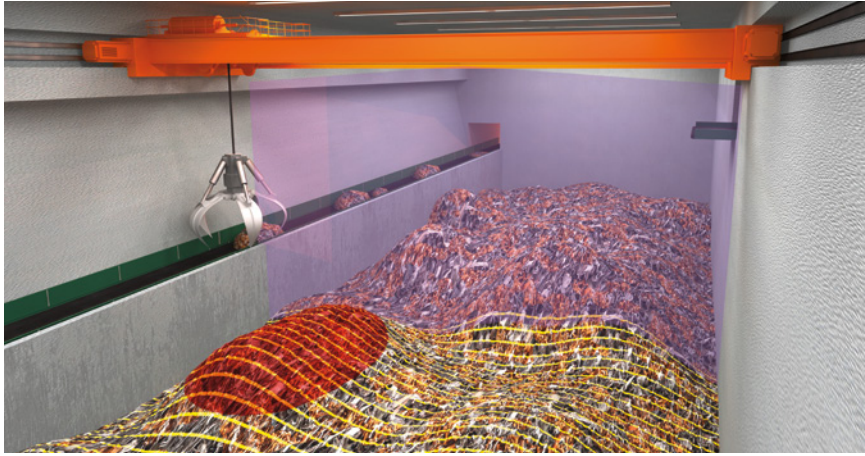

Concise description

The goal is to control the gripper of a gantry crane in the bunker of a waste incineration plant so that waste is always picked up at the point where the fill level is highest. Rather than making sporadic measurements, the system needed to capture the bunker's entire width and provide reliable measurement values regardless of the waste composition and

harsh operating conditions. Permanently fanned light pulses from the sensor provide accurate measurement data. This principle of operation can be used in various applications with gantry cranes such as for chippings bunkers, stacking of slabs or anywhere where cranes need to be positioned automatically.

Implementation

The laser measurement sensor moves over the bunker and emits permanently fanned light pulses that are reflected by the surface of the waste. The shorter the light's transit time, the greater the fill level at the relevant point. A height profile is

calculated in the evaluation unit based on the measured data and information about the highest point of the waste pile in the bunker is sent to the crane control. The gripper is subsequently positioned at this point.

Customer benefits

Automatic waste removal at the relevant highest point ensures continuous feeding of furnaces. In addition, uniform

and fast removal from the waste bunker provides better capacity usage across the entire waste incineration plant.



Applications Finder

- For up-to-date application solutions, visit SICK's web site
→ www.mysick.com/applications
- The "Applications Finder" will lead you to further solutions that use SICK products

Other applications

- Measurement of fill height and fill width of rubber mass
- Checking for empty of transport crates
- Detection of fill level height and distribution in waste incineration plants
- Identification of a 3D profile of bulk materials in a coal bunker

C

Recommended products

LMS1xx (Outdoor)	D-14
LMS5xx (Outdoor)	D-20
LD-OEM	D-26
LD-LRS	D-30
LMS4xx	E-18



D

Compact, reliable detection and distance measurement at all times

Laser measurement technology sensors can be used for a wide range of applications. These sensors detect both 2D and multi-dimensional contour data and can process information either externally or in the sensor itself. They are ideal for indoor and outdoor applications, including anti-collision in harbors, classification in traffic, detection in building automation, or position evaluation in navigation.

Your benefits





- Low sensitivity to ambient influences, improving efficiency
- Ideal for a wide range of anti-collision tasks
- Can be mounted in “critical” work areas
- Flexible use for monitoring surfaces
- On-board applications since no external evaluating electronics are required
- Only one mounting point for observing and monitoring large surfaces





D

Laser measurement technology components

Product family overview D-2

	TiM3xx D-6 Perfect in detail, brilliant overall
	S100 D-10 Compact, flexible
	LMS1xx D-14 In full view in all weather – compact and economical
	LMS5xx D-20 More than meets the eye. Compact unit for big solutions.

	LD-OEM D-26 360° field of view for more accurate measurement and detection
	LD-LRS D-30 Powerful, long-range scanning for outdoor environments
	LD-MRS D-34 Multi-layer scanner for harsh environmental conditions

Product family overview

	 <p>TIM3xx</p>	 <p>S100</p>	
	Perfect in detail, brilliant overall	Compact, flexible	
Technical data overview			
Field of application	Indoor	Indoor	
Field of view	270°	270°	
Operating range	0.05 m ... 4 m	0 m ... 10 m	
Max. range with 10 % reflectivity	2 m	4.5 m	
Scanning frequency	-	25 Hz	
Heating	-	-	
Serial	-	✓ (RS-232)	
Ethernet	-	-	
CAN bus	-	-	
USB	✓, micro USB	-	
Weight	150 g	1.2 kg	
At a glance			
			
	<ul style="list-style-type: none"> • Configure without a PC using “touch and teach” • Small, lightweight and economical measurement system • Field evaluation using intelligent algorithms • Set parameter interface is accessible while device is mounted • One of the smallest laser scanners on the market • Proven industrial design • Low power consumption (3 W) 	<ul style="list-style-type: none"> • Small, lightweight and economical measurement system • Field evaluation using intelligent algorithms • Parameter setting interface is accessible from the front while the device is mounted 	
Detailed information	→ D-6	→ D-10	

D



LMS1xx

In full view in all weather – compact and economical



LMS5xx

More than meets the eye. Compact unit for big solutions.

Indoor / Outdoor / Security	Indoor / Outdoor
270°	190°
0.5 m ... 50 m	0 m ... 80 m
18 m	26 m / 40 m
25 Hz / 50 Hz	25 Hz / 35 Hz / 50 Hz / 75 Hz / 100 Hz
Yes (depending on type)	Yes (depending on type)
✓ (RS-232)	✓ (RS-232, RS-422)
✓	✓
✓	- / ✓
-	✓, mini USB
1.1 kg	3.7 kg



- Economical measurement sensor
- Real-time output of measurement data via Ethernet interface
- Field evaluation using intelligent algorithms and programmable applications
- Number of switching outputs can be expanded via external CAN modules
- Parameter setting interface is accessible from the front while the device is mounted
- Rugged IP-67-rated housing

→ D-14



- Powerful and efficient laser measurement sensor for ranges of up to 80 m
- Outstanding performance in adverse environmental conditions due to multi-echo technology
- IP 67 enclosure rating, built-in heater, highly compact design
- Low power consumption
- Fast signal processing
- Multiple I/Os
- Synchronization of multiple sensors possible

→ D-20

D

Product family overview



LD-OEM

360° field of view for more accurate measurement and detection

Technical data overview

Field of application	Indoor
Field of view	360°
Operating range	0.5 m ... 250 m
Max. range with 10 % reflectivity	35 m
Scanning frequency	5 Hz ... 15 Hz
Heating	-
Serial	✓ (RS-232, RS-422)
Ethernet	✓
CAN bus	✓
Weight	2.4 kg

At a glance



- High angular resolution
- Real-time output of measurement data via Ethernet interface
- High ambient light immunity
- Up to 4 fields can be programmed

Detailed information

→ D-26

D



LD-LRS

Powerful, long-range scanning for outdoor environments



LD-MRS

Multi-layer scanner for harsh environmental conditions

	Indoor / Outdoor	Outdoor
	360°	85°
	0.5 m ... 250 m	0.5 m ... 250 m
	80 m / 150 m	50 m / 30 m
	5 Hz ... 10 Hz	12.5 Hz ... 50 Hz, object tracking at 12.5 Hz
	Yes (depending on type)	-
	✓ (RS-232, RS-422)	✓ (RS-232)
	✓	✓
	✓	✓
	4.1 kg / 9.1 kg	1 kg



- Long range, even when detecting dark objects
- High angular resolution
- High ambient light immunity
- Small light spot diameter
- Up to 4 fields can be programmed

→ D-30



- Simultaneous measurement on 4 layers
- Excellent outdoor capabilities with multipulse technology
- Compact and lightweight design. Volume is less than 1 liter, weight is approximately 1 kg
- Wide temperature range with low power consumption: -40 °C to +70 °C at 8 W
- Operation possible even with supply voltages from 9 V DC

→ D-34

D

Perfect in detail, brilliant overall



Product description

The TiM3xx is the next step in the evolution of laser scanners. The sensor uses SICK's new HDDM (High-definition Distance Measurement) technology, which reduces machine downtime due to its extremely high measurement reliability and immunity to ambient light. The design of the TiM3xx offers a large detection range of up to 4 m. This compact sensor is one of the smallest laser scanners on the market, making it easily hidden from view. Its "touch and teach" feature enables users to set the

sensor's surveillance area without a PC. In addition, 16 preconfigured field sets (3 fields per set) can be selected via the inputs. The TiM3xx is a flexible, cost-efficient and easy-to-use laser scanner for applications in logistics and factory automation. It can be used on fixed applications or mobile vehicles. With its low power consumption and rugged design, plus optional protection cover and shock absorber, the TiM3xx is ideal for AGVs and other industrial vehicles.

D

At a glance

- Configure without a PC using "touch and teach"
- Small, lightweight and economical measurement system
- Field evaluation using intelligent algorithms
- Set parameter interface is accessible while device is mounted
- One of the smallest laser scanners on the market
- Proven industrial design
- Low power consumption (3 W)

Your benefits

- Low cost of ownership
- Easily hidden from view due to small dimensions
- Low installation costs and exchange time due to D-Sub connector
- Long operation for battery-driven vehicles
- Intuitive and preconfigured fields ensure short installation time
- Reduced hardware costs since one sensor can be used for large anti-collision fields
- No wiring necessary between sender and receiver



Additional information

- Detailed technical data..... D-7
- Ordering information..... D-8
- Operating range diagram..... D-8
- Recommended accessories..... D-8

→ www.mysick.com/en/TiM3xx

Detailed technical data

Features

Field of application	Indoor
Type	Short Range
Light source	Infrared (850 nm)
Laser class	1, eye-safe (EN 60825-1 (2007-10))
Field of view	270°
Operating range	0.05 m ... 4 m
Max. range with 10 % reflectivity	2 m

Performance

Response time	Typ. 134 ms
Detectable object shape	Almost any
Systematic error	± 40 mm
Statistical error	± 30 mm
Integrated application	Field evaluation
Number of field sets	16 field triples (48 fields, thereof 1 triple (3 fields) programmable directly at the scanner)
Simultaneous processing cases	1 (3 fields)

Interfaces

USB	Function	✓, micro USB AUX
Switching inputs		4
Switching outputs		3 (plus 1 x "device ready")
Delay time		134 ms ... 30,000 ms (programmable)
Dwell time		67 ms ... 10,000 ms (programmable)
Optical indicators		2 LEDs (ON, switching status)

Mechanics/electronics

Electrical connection	1 15-pin D-sub HD plug (0.9 m)
Operating voltage	10 V DC ... 28 V DC
Power consumption	Typ. 3 W, without output load
Housing color	Light blue (RAL 5012)
Enclosure rating	IP 65 (EN 60529/A1:2000-02)
Protection class	III (EN 60950-1/A11 (2009-03))
Weight	150 g, without connecting cables
Dimensions	60 mm x 60 mm x 79 mm

Ambient data

Object remission	4 % ... > 1,000 % (reflectors)
Electromagnetic compatibility (EMC)	EN 61000-6-3 (2007-01) / EN 61000-6-2 (2005-08)
Vibration resistance	EN 60068-2-6 (2008-02)
Shock resistance	EN 60068-2-27 (2009-05)
Ambient operating temperature	-10 °C ... +50 °C
Storage temperature	-30 °C ... +70 °C
Ambient light safety	15,000 lx

Ordering information

Sub product family	Type	Field of application	Model name	Part no.
TiM31x	Short Range	Indoor	TiM310-1030000	1052627

Operating range diagram

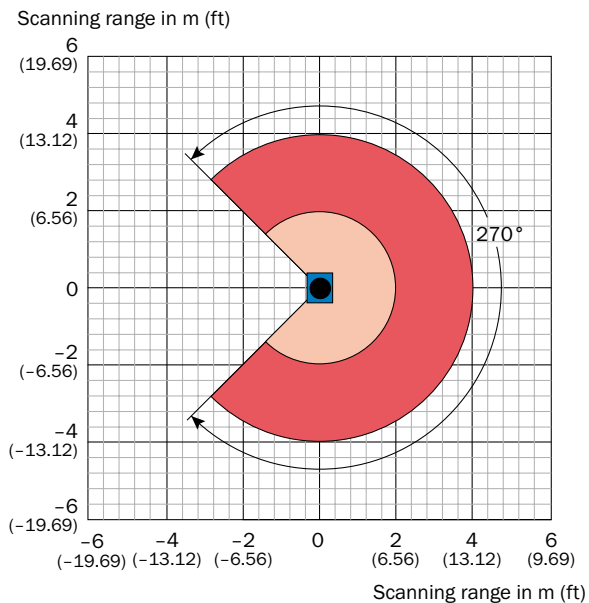



- Scanning range max. 4 m (13.12 ft)
- Scanning range for objects up to 10 % remission 2 m (6.56 ft)

D

Recommended accessories

Plug connectors and cables

	Brief description	Part no.
	Extension cable, 2 m, 15-wired, shielded, with 15-pin D-sub HD (socket/open end) AWG26	2043413
	USB cable, 2 m	6036106

For additional accessories, please see page F-2

D

Compact, flexible



Product description

Damaged goods or defective machines and equipment can impede or stop processes – causing expensive downtime. The S100 laser scanner offers an efficient and economical way to prevent unnecessary downtime. The S100 is a non-safety-rated laser scanner that

was specially developed for collision avoidance in areas where people are not present or to help solve customers' supplemental monitoring applications. The S100 detects problems, monitors distances and prevents potential collisions.

At a glance

- Small, lightweight and economical measurement system
- Field evaluation using intelligent algorithms
- Parameter setting interface is accessible from the front while the device is mounted

Your benefits

- Simple mounting due to lightweight design
- No wiring between sender and receiver
- Rapid diagnostics due to a 7-segment display, reducing downtime
- Connectivity in both back and bottom of device provide improved installation flexibility
- 270° scanning angle makes it ideal for both horizontal and vertical applications

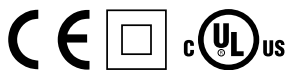

Additional information

Detailed technical data D-11
 Ordering information D-12
 Operating range diagram D-12
 Recommended accessories D-13
 Dimensional drawing G-2

→ www.mysick.com/en/S100

D

Detailed technical data

Features

Field of application	Indoor
Type	Short Range
Light source	Infrared (905 nm)
Laser class	1 (21CFR 1040.10, 21CFR 1040.11, IEC60825-1:2001)
Field of view	270°
Scanning frequency	25 Hz
Angular resolution	0.5°
Operating range	0 m ... 10 m
Max. range with 10 % reflectivity	4.5 m

Performance

	S100 Standard	S100 Professional
Detectable object shape	Almost any (diameter: 30 mm, 40 mm, 50 mm, 70 mm, 150 mm (selectable))	
Integrated application	Field evaluation	
Number of field sets	1 field pair (2 fields)	16 field pairs (32 fields)
Simultaneous processing cases	1 (2 fields)	

Interfaces

	S100 Standard	S100 Professional
Serial (RS-232)	✓	
Switching inputs	1	4
Switching outputs	2	
Optical indicators	1 7-segment display (contamination warning, initial condition)	

Mechanics/electronics

Electrical connection	1 system plug with screw terminal block
Operating voltage	16.8 V DC ... 30 V DC
Power consumption	8 W
Output current	≤ 250 mA
Housing color	Black (RAL 9005)
Enclosure rating	IP 65 (EN 60529, Section 14.2.5)
Protection class	II (VDE 0106, EN50178)
Weight	1.2 kg, without connecting cables
Dimensions	105 mm x 102 mm x 152 mm

Ambient data

Object remission	1.8 % ... > 1,000 % (reflectors)
Ambient operating temperature	-10 °C ... +50 °C
Storage temperature	-30 °C ... +70 °C

Ordering information

- **Type:** Short Range
- **Field of application:** Indoor
- **Switching outputs:** 2
- **Object remission:** 1.8 % ... > 1,000 %, reflectors
- **Housing color:** Black (RAL 9005)

Sub product family	Model name	Part no.
S100 Standard	S10B-9011BA	1042266
S100 Professional	S10B-9011DA	1042267

Operating range diagram

Scanning range in m (ft)

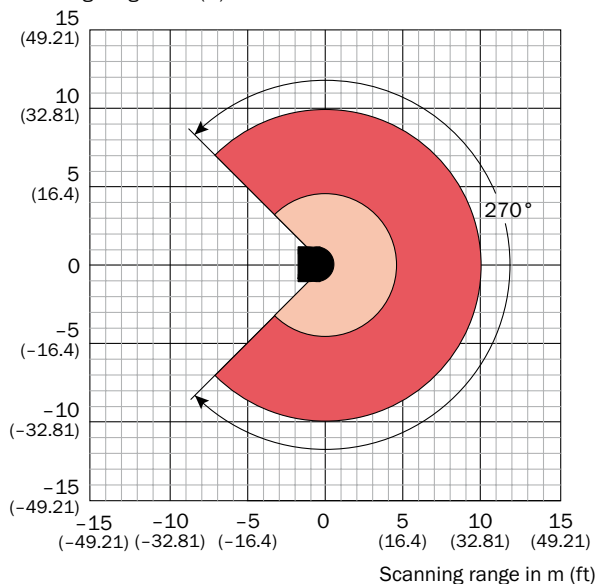



- Scanning range max. 10 m (32.81 ft)
- Scanning range for objects up to 10 % remission 4.5 m (14.76 ft)



D

Recommended accessories

Mounting brackets/plates

	Brief description	Part no.
	Mounting set 1a: bracket for mounting to wall or machine from the back	2034324
	Mounting set 1b: bracket for mounting to wall or machine from the back, with cover protection	2034325

Plug connectors and cables

	Brief description	Model name	Part no.
	Parameter setting cable for PC connection (9-pin Sub-D) to CDF600 (4-pin M8), 2 m	DSL-8D04G02M025KM1	6021195
	System plug S1xx with one cable gland M16 and one blanking plug M12, on the rear, without cable	SX0B-A0000G	2032807

Programming/Configuration Tool

	Brief description	Part no.
	Scan finder, receiver to localize infrared scans	6020756

For additional accessories, please see page F-2

In full view in all weather – compact and economical



Product description

The LMS1xx laser measurement sensors are the small and economical option in SICK’s family of laser measurement technology. They are an ideal solution for indoor and outdoor applications that don’t require long-range, high-speed measurements. The sensor integrates the sender and receiver into a single housing, providing a compact, lightweight design that saves space. Advanced filtering technol-

ogy eliminates false trips caused by environmental factors like fog, rain and snow. In addition, the LMS1xx is an affordable sensor with low operating costs. Despite its small size, the LMS1xx offers big advantages, including double-pulse technology that doubles the number of measurement points and even permits mounting behind glass.

At a glance

- Economical measurement sensor
- Real-time output of measurement data via Ethernet interface
- Field evaluation using intelligent algorithms and programmable applications
- Number of switching outputs can be expanded via external CAN modules
- Parameter setting interface is accessible from the front while the device is mounted
- Rugged IP-67-rated housing

Your benefits

- Lightweight housing makes it easy to mount
- No wiring between sender and receiver
- Advanced filtering technology rigorously reduces false trips caused by outdoor environmental factors like fog, rain and snow
- Optional external CAN I/O module increases number of switching outputs for greater application flexibility
- Fast, easy commissioning due to SOPAS software



Additional information

Detailed technical data.....D-15
 Ordering information.....D-17
 Operating range diagram.....D-17
 Recommended accessories.....D-18

→ www.mysick.com/en/LMS1xx

D

Detailed technical data

Features

	LMS100	LMS111	LMS12x	LMS13x	LMS151
Field of application	Indoor	Outdoor	Security, Indoor	Security, Outdoor	Outdoor
Type	Short Range				
Light source	Infrared (905 nm)				
Laser class	1 (IEC 60825-1 (2007-3))				
Field of view	270°				
Scanning frequency	25 Hz / 50 Hz				
Angular resolution	0.25°, 0.5°				
Heating	-	Yes	-	Yes	
Operating range	0.5 m ... 20 m				0.5 m ... 50 m
Max. range with 10 % reflectivity	18 m				
Amount of evaluated echoes	2				
Fog correction	Yes				

Performance

	LMS100	LMS111	LMS12x	LMS13x	LMS151
Response time	≥ 20 ms		20 ms		≥ 20 ms
Detectable object shape	Almost any				
Systematic error	± 30 mm				
Statistical error	± 12 mm				
Integrated application	Field evaluation				
Number of field sets	10 fields				
Simultaneous processing cases	10				

Interfaces

	LMS100	LMS111	LMS12x	LMS13x	LMS151
Serial (RS-232)	Function	✓ Host, AUX			
	Data transmission rate	9.6 kBaud ... 115.2 kBaud			
Ethernet	Function	✓ Host			
	Data transmission rate	10/100 Mbit			
	Protocol	TCP/IP, OPC			
CAN bus	Function	✓ Outputs extension			
	Switching inputs	2		4 (2 x IN, 2 x increment (1-phase))	2
Switching outputs	3		3 (2 relay, 1 digital)		3
Optical indicators	1 7-segment display (plus 5 LEDs showing device status, contamination warning and initial condition)				

Mechanics/electronics

	LMS100	LMS111	LMS12x	LMS13x	LMS151
Electrical connection	1 system plug with screw terminal block	M12 circular plug-in connector	1 system plug with screw terminal block	1 M12 circular plug-in connector	
Operating voltage	10.8 V DC ... 30 V DC		9 V DC ... 30 V DC		10.8 V DC ... 30 V DC
Power consumption	20 W	60 W	20 W	60 W	
Housing color	Light blue (RAL 5012)	Gray (RAL 7032)	Gray (RAL 7032) Black (RAL 9005) Signal white (RAL 9003) (depending on type)		Gray (RAL 7032)
Enclosure rating	IP 65 (EN 60529, Section 14.2.5)	IP 67 (EN 60529, Section 14.2.7)	IP 65 (EN 60529, Section 14.2.5)	IP 67 (EN 60529, Section 14.2.5)	IP 67 (EN 60529, Section 14.2.7)
Protection class	III (EN 50178 (1997;10))				
Weight	1.1 kg, without connecting cables				
Dimensions	105 mm x 102 mm x 152 mm	105 mm x 102 mm x 162 mm	105 mm x 102 mm x 152 mm	105 mm x 102 mm x 162 mm	

Ambient data

	LMS100	LMS111	LMS12x	LMS13x	LMS151
Object remission	2 % ... > 1,000 % (reflectors)				
Electromagnetic compatibility (EMC)	EN 61000-6-2:2005 / EN 61000-6-4 (2007-01)				
Vibration resistance	EN 60068-2-6 (1995-04)				
Shock resistance	EN 60068-2-27 (1993-03)				
Ambient operating temperature	0 °C ... +50 °C	-30 °C ... +50 °C	0 °C ... +50 °C	-30 °C ... +50 °C	
Storage temperature	-30 °C ... +70 °C				
Ambient light safety	40,000 lx				

D

Ordering information

- **Type:** Short Range
- **Object remission:** 2 % ... > 1,000 %, reflectors

Sub product family	Field of application	Heating	Switching outputs	Housing color	Model name	Part no.
LMS100	Indoor	-	3	Light blue (RAL 5012)	LMS100-10000	1041113
LMS111	Outdoor	Yes	3	Gray (RAL 7032)	LMS111-10100	1041114
LMS12x	Security, Indoor	-	3 (2 relay, 1 digital)	Gray (RAL 7032)	LMS121-10000 Security	1051384
				Black (RAL 9005)	LMS122-10000 Security	1044322
				Signal white (RAL 9003)	LMS123-10000 Security	1044321
LMS13x	Security, Outdoor	Yes	3 (2 relay, 1 digital)	Gray (RAL 7032)	LMS131-10100 Security	1051379
				Black (RAL 9005)	LMS132-10100 Security	1051402
				Signal white (RAL 9003)	LMS133-10100 Security	1051403
LMS151	Outdoor	Yes	3	Gray (RAL 7032)	LMS151-10100	1047607

Operating range diagram

LMS100, LMS111, LMS12x, LMS13x

Scanning range in m (ft)

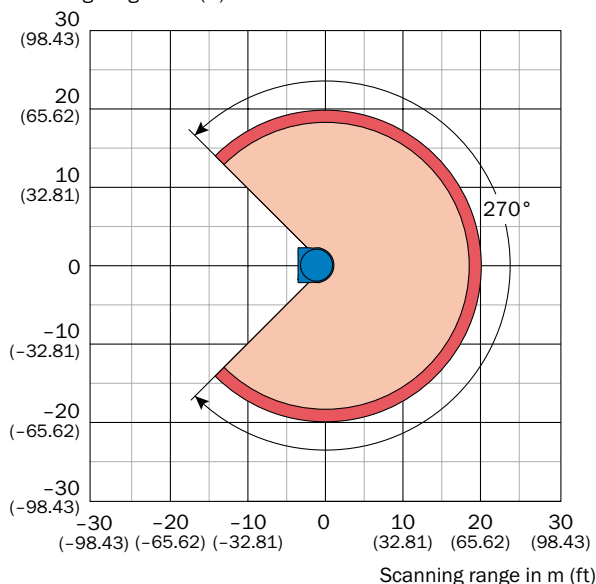

- Scanning range max. 20 m (65.62 ft)
- Scanning range for objects up to 10 % remission 18 m (59.06 ft)

LMS151

Scanning range in m (ft)

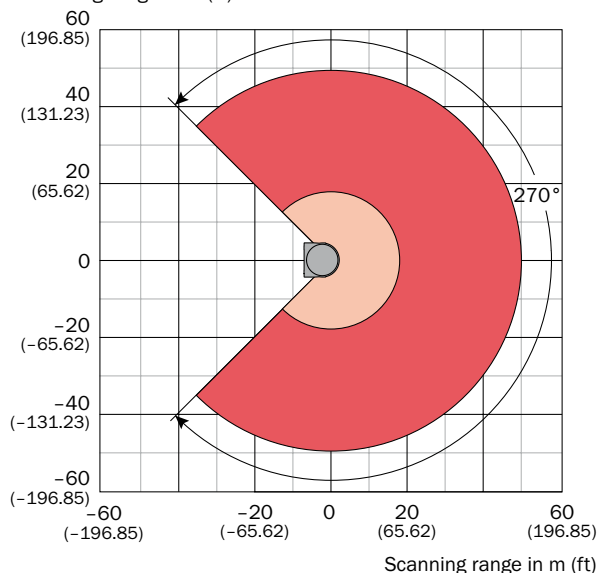

- Scanning range max. 50 m (164.04 ft)
- Scanning range for objects up to 10 % remission 18 m (59.06 ft)

D

Recommended accessories



Device protection (mechanical)

	Brief description	Part no.	LMS100	LMS111	LMS12x	LMS13x	LMS151
	Weather hood, 190°	2046459	-	●	-	●	●





Modules

	Brief description	Part no.	LMS100	LMS111	LMS12x	LMS13x	LMS151
	External CAN extension module for up to 8 additional outputs	6038825	●	●	●	●	●

Mounting brackets/plates

	Brief description	Part no.	LMS100	LMS111	LMS12x	LMS13x	LMS151
	Standard mounting set for 190°/270° weather hood	2046025	-	●	-	●	●
	Mounting set 1a: bracket for mounting to wall or machine from the back	2034324	●	●	●	●	●
	Mounting set 1b: bracket for mounting to wall or machine from the back, with cover protection	2034325	●	●	●	●	●

Plug connectors and cables

	Brief description	Part no.	LMS100	LMS111	LMS12x	LMS13x	LMS151
	I/O connection cable, 8-pole, shielded, M12 plug, 8-pin (A-type encoded) / open end, 5 m	6036155	-	●	-	●	●
	Ethernet cable, 4-pole, shielded, M12 plug, 4-pin (D-type encoded) / RJ-45 plug, 8-pin, 5 m	6034415	●	●	●	●	●
	Power supply cable, 4 x 0,50 mm ² , shielded, M12 socket, 5-pin (A-type encoded) / open end, 5 m	6036159	-	●	-	●	●
	Data (RS-232/422) and synchronization input cable, 8-pole, shielded, M12 socket, 8-pin (A-type encoded) / open end, 5 m	6036153	-	●	-	●	●

Programming/Configuration Tool

	Brief description	Part no.	LMS100	LMS111	LMS12x	LMS13x	LMS151
	Scan finder, receiver to localize infrared scans	6020756	●	●	●	●	●

Terminal and alignment brackets

	Brief description	Part no.	LMS100	LMS111	LMS12x	LMS13x	LMS151
	Rapid-release mounting set for 190°/270° weather hood	2046989	-	●	-	●	●

For additional accessories, please see page F-2



More than meets the eye.
Compact unit for big solutions.



Product description

The LMS5xx laser measurement sensor is the successor of the widely used LMS2xx series. It offers a host of new features to boost performance in existing applications and break ground for new applications. The powerful multi-echo high-speed sampling technology provides dramatically improved reliability even in the worst weather conditions. Major

reduction in power consumption and intelligent self-monitoring features for reduced maintenance lead to low total cost of ownership. With two variants, Lite and PRO, users can choose the best solution for their application. LMS5xx has the best performance/price ratio in this sensor class on the market.

At a glance

- Powerful and efficient laser measurement sensor for ranges of up to 80 m
- Outstanding performance in adverse environmental conditions due to multi-echo technology
- IP 67 enclosure rating, built-in heater, highly compact design
- Low power consumption
- Fast signal processing
- Multiple I/Os
- Synchronization of multiple sensors possible

Your benefits

- Superior performance in a vast range of applications
- Smallest laser measurement sensor with highest accuracy in its class
- Comprehensive range of lines and models to suit all performance and price requirements
- Fast, reliable object detection in nearly any weather conditions
- Low power consumption reduces total cost of ownership
- Best price/performance ratio in this sensor class on the market
- Fast, easy commissioning due to SOPAS software
- Self-monitoring functions increase system availability



Additional information

- Detailed technical data.....D-21
- Ordering information.....D-23
- Operating range diagram.....D-23
- Recommended accessories.....D-24

→ www.mysick.com/en/LMS5xx

D

Detailed technical data

Features

	LMS500	LMS511	LMS531
Field of application	Indoor	Outdoor	Outdoor, Security
Type	Mid Range		
Version	Lite / PRO (depending on type)		Lite
Resolution power	High Resolution	Standard Resolution, High Resolution (depending on type)	Standard Resolution
Light source	Infrared (905 nm)		
Laser class	1, eye-safe (IEC 60825-1 (2007-6))		
Field of view	190°		
Scanning frequency	Lite PRO	25 Hz / 35 Hz / 50 Hz / 75 Hz 25 Hz / 35 Hz / 50 Hz / 75 Hz / 100 Hz	25 Hz / 35 Hz / 50 Hz / 75 Hz -
Angular resolution	Lite PRO	0.25°, 0.5°, 1° 0.167°, 0.25°, 0.333°, 0.5°, 0.667°, 1°	0.25°, 0.5°, 1° -
Heating	-	Yes	
Operating range	0 m ... 80 m		
Max. range with 10 % reflectivity	26 m	40 m / 26 m (depending on type)	40 m
Spot size	High Resolution Standard Resolution	4.7 mrad 11.9 mrad	- 11.9 mrad
Amount of evaluated echoes	Lite PRO	2 5	2 -
Fog correction	No	Yes	

Performance

	LMS500	LMS511	LMS531
Response time	Lite PRO	≥ 13 ms ≥ 10 ms	≥ 13 ms -
Detectable object shape	Almost any		
Systematic error	High Resolution Standard Resolution	± 25 mm (1 m ... 10 m) ± 35 mm (10 m ... 20 m) - ± 25 mm (1 m ... 10 m) ± 35 mm (10 m ... 20 m) ± 50 mm (20 m ... 30 m)	- ± 25 mm (1 m ... 10 m) ± 35 mm (10 m ... 20 m) ± 50 mm (20 m ... 30 m)
Statistical error	High Resolution Standard Resolution	± 7 mm (1 m ... 10 m) ± 9 mm (10 m ... 20 m) - ± 7 mm (1 m ... 10 m) ± 9 mm (10 m ... 20 m) ± 6 mm (1 m ... 10 m) ± 8 mm (10 m ... 20 m) ± 14 mm (20 m ... 30 m)	- ± 6 mm (1 m ... 10 m) ± 8 mm (10 m ... 20 m) ± 14 mm (20 m ... 30 m)
Integrated application	Field evaluation		
Number of field sets	Lite PRO	4 fields 10 fields	4 fields -
Simultaneous processing cases	Lite PRO	4 10	4 -

Interfaces

		LMS500	LMS511	LMS531
Serial (RS-232, RS-422)	Function	✓ Host		
	Data transmission rate	9.6 kBaud ... 500 kBaud		
Ethernet	Function	✓ Host		
	Data transmission rate	10/100 Mbit		
	Protocol	TCP/IP, OPC		
CAN bus	Function	- / ✓ (depending on type)	-	-
	Outputs extension			
USB	Function	✓, mini USB AUX		
	Data transmission rate	9.6 kBaud ... 500 kBaud		
Switching inputs	Lite	2		2
	PRO	4 (Encoder)		-
Switching outputs	Lite	3		3 (2 relay, 1 digital)
	PRO	6		-
Optical indicators		5 LEDs (additional 7-segment display)		

Mechanics/electronics

	LMS500	LMS511	LMS531
Electrical connection	1 system plug with screw terminal block	1 M12 4-pin plug-in connector	
Operating voltage	24 V DC		
Power consumption	22 W	22 W, + 43 W heating (typical)	
Housing color	Light blue (RAL 5012)	Gray (RAL 7032)	
Enclosure rating	IP 65 (EN 60529, Section 14.2.7)	IP 67 (EN 60529, Section 14.2.7)	
Protection class	III (EN 60529, Section 14.2.7)		
Weight	3.7 kg		
Dimensions	160 mm x 155 mm x 185 mm		

Ambient data

	LMS500	LMS511	LMS531
Object remission	2 % ... > 1,000 % (reflectors)		
Electromagnetic compatibility (EMC)	EN 61000-6-2:2005 / EN 61000-6-3 (2001-10)		
Vibration resistance	EN 60068-2-6 (1995-04)		
Shock resistance	EN 60068-2-27 (1993-03), EN 60068-2-29 (1993-04)		
Ambient operating temperature	0 °C ... +50 °C	-30 °C ... +50 °C	
Storage temperature	-12 °C ... +50 °C	-30 °C ... +70 °C	
Ambient light safety	70,000 lx		

Ordering information

- **Type:** Mid Range
- **Object remission:** 2 % ... > 1,000 %, reflectors

Sub product family	Field of application	Version	Resolution power	Model name	Part no.
LMS500	Indoor	Lite	High Resolution	LMS500-21000 Lite	1054153
		PRO	High Resolution	LMS500-20000 PRO	1047468
LMS511	Outdoor	Lite	Standard Resolution	LMS511-11100 Lite	1054155
			High Resolution	LMS511-21100 Lite	1054154
		PRO	Standard Resolution	LMS511-10100 PRO	1046135
			High Resolution	LMS511-20100 PRO	1047782
LMS531	Outdoor	Lite	Standard Resolution	LMS531-11100 Lite	1055376

Operating range diagram

LMS5xx High Resolution

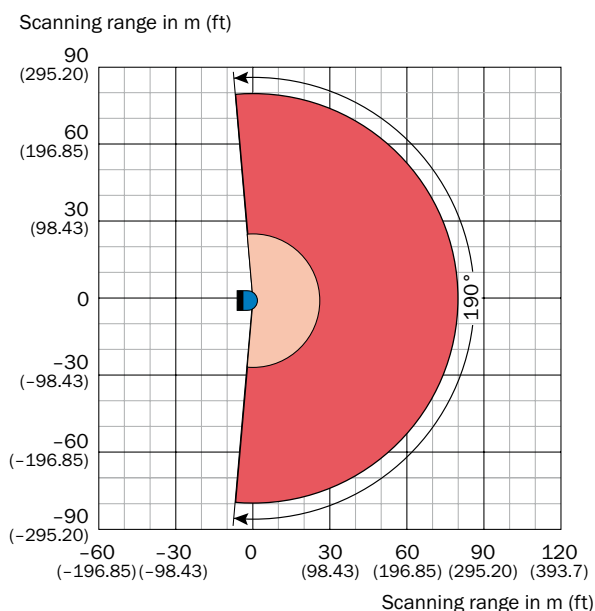

- Scanning range max. 80 m (262.47 ft)
- Scanning range for objects up to 10 % remission 26 m (85.3 ft)

LMS5xx Standard Resolution

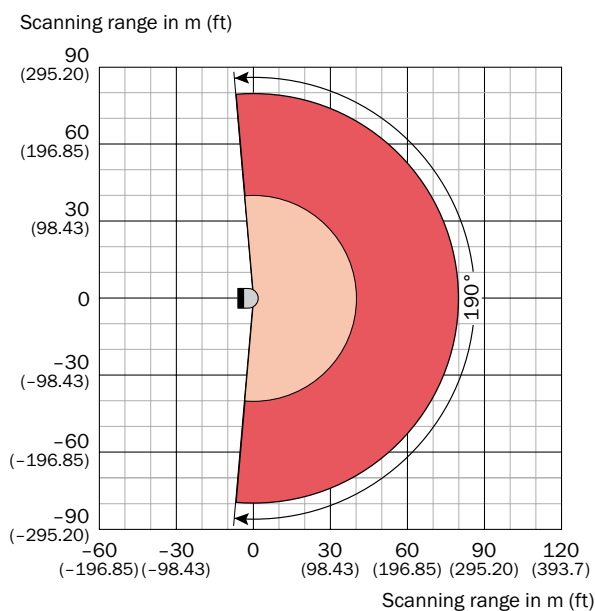

- Scanning range max. 80 m (262.47 ft)
- Scanning range for objects up to 10 % remission 40 m (131.23 ft)

D

Recommended accessories





Device protection (mechanical)

Brief description	Part no.	LMS500 Lite	LMS500 PRO	LMS511 Lite	LMS511 PRO	LMS531 Lite
Protection hood	2056850	-	-	●	●	●

Mounting brackets/plates

Brief description	Part no.	LMS500 Lite	LMS500 PRO	LMS511 Lite	LMS511 PRO	LMS531 Lite
 Mounting set 1	2015623	●	●	●	●	●

Plug connectors and cables

Brief description	Part no.	LMS500 Lite	LMS500 PRO	LMS511 Lite	LMS511 PRO	LMS531 Lite
 Ethernet cable, 4-pole, shielded, M12 plug, 4-pin (D-type encoded) / RJ-45 plug, 8-pin, 5 m	6034415	●	●	●	●	●
 Power supply cable, 4 x 0,50 mm ² , shielded, M12 socket, 5-pin (A-type encoded) / open end, 5 m	6036159	-	-	●	●	●
 Data (RS-232/-422) and synchronization input cable, 8-pole, shielded, M12 socket, 8-pin (A-type encoded) / open end, 5 m	6036153	-	-	●	-	●
 I/O connection cable, 8-pole, shielded, M12 plug, 8-pin (A-type encoded) / open end, 5 m	6036155	-	-	●	-	●
I/O connection cable, 12-pole, shielded, M12 plug, 12-pin (A-type encoded) / open end, 5 m	6042732	-	-	-	●	-
Data (RS-232/-422) and I/O connection cable, 12-pole, shielded, M12 socket, 12-pin (A-type encoded) / open end, 5 m	6042735	-	-	-	●	-

For additional accessories, please see page F-6

D



360° field of view for more accurate measurement and detection



Product description

The LD-OEM laser measurement system has been designed for use in harsh environmental conditions, such as those found in the steel and port automation industries. The LD-OEM offers a high resolution that enables the measurement and exact positioning of any object size. The LD-OEM is based on a dual processor hardware structure.

The first DSP (digital signal processor) controls laser measurement and the I/O

data flow, while the second DSP is dedicated to area monitoring. Using simple configuration software, you can define the shape and size of the area to be monitored, taking into account all fixed on-site features and objects. In addition, the area monitoring application can be replaced by another application that has been programmed elsewhere, e.g., profile detection for robots.

At a glance

- High angular resolution
- Real-time output of measurement data via Ethernet interface
- High ambient light immunity
- Up to 4 fields can be programmed

Your benefits

- High level of reliability, even in poor environmental conditions
- Small objects can be detected at long ranges
- High-performance time-of-flight sensor for measurement and positioning, area monitoring and collision prevention applications
- Flexible integration in customer-designed applications



Additional information

- Detailed technical dataD-27
- Ordering informationD-28
- Operating range diagramD-28
- Recommended accessoriesD-29
- Dimensional drawingG-3

→ www.mysick.com/en/LD-OEM

D

Detailed technical data

Features

Field of application	Indoor
Type	Mid Range
Light source	Infrared (905 nm)
Laser class	1, eye-safe (EN/IEC 60825-1)
Field of view	360°
Scanning frequency	5 Hz ... 15 Hz
Angular resolution	0.125°, 0.25°, 0.5°, 1°, 1.5°
Operating range	0.5 m ... 250 m
Max. range with 10 % reflectivity	35 m
Fog correction	No

Performance

Response time	≥ 66 ms
Detectable object shape	Almost any
Systematic error	± 38 mm
Statistical error	± 25 mm
Integrated application	Field evaluation
Number of field sets	4 fields
Simultaneous processing cases	4

Interfaces

Serial (RS-232, RS-422)	✓
	Data transmission rate 4,800 Baud ... 115,200 Baud
Ethernet	✓
	Data transmission rate ≤ 10 Mbit/s Protocol TCP/IP
CAN bus	✓
	Data transmission rate 10 kbit/s ... 1 Mbit/s Protocol Standard 2.0.A
Switching outputs	4 (digital)
Optical indicators	4 LEDs (status display)

Mechanics/electronics

Electrical connection	1 6-pin terminal block 1 15-pin D-Sub HD plug
Operating voltage	24 V DC, ± 15 %
Power consumption	36 W
Housing	Die-cast aluminum
Housing color	Light blue (RAL 5012)
Enclosure rating	IP 65
Protection class	III
Weight	2.4 kg
Dimensions	115 mm x 120 mm x 222 mm

Ambient data

Ambient operating temperature	0 °C ... +50 °C
Storage temperature	-20 °C ... +80 °C
Permissible relative humidity	85 %, non-condensing

Ordering information

Type	Field of application	Switching outputs	Housing color	Model name	Part no.
Mid Range	Indoor	4 (digital)	Light blue (RAL 5012)	LD-OEM1000	1028698

Operating range diagram

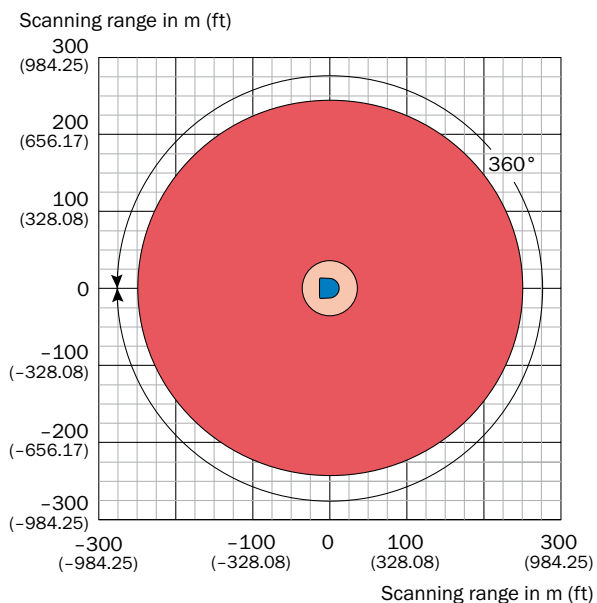

- Scanning range max. 250 m (820.21 ft)
- Scanning range for objects up to 10 % remission 36 m (118.11 ft)

Recommended accessories

Plug connectors and cables

	Brief description	Part no.
	CAN cable, 3 m	6032845

Programming/Configuration Tool

	Brief description	Part no.
	Scan finder, receiver to localize infrared scans	6020756

Terminal and alignment brackets

	Brief description	Part no.
	Mounting holder, complete with mounting material and tools	5311055

For additional accessories, please see page F-8

D

Powerful, long-range scanning for outdoor environments



D

Product description

Automation of ship-loading processes with the LD-LRS

The LD-LRS laser measurement system, which has a 250 m scanning range, is one part of the state-of-the-art technology to automate STS crane loading and unloading. The powerful laser optics perform a non-contact scan of the container stacks and accurately detect any obstacles that may interfere with the operation.

Stockpile measuring

The profile measurement data for the bulk goods fill level can be converted

into a 3D model. This results in accurate, real-time visualization of the bulk goods surface profile, optimizing the discharge.

Container classification

The LD-LRS laser measurement system automates the procedure for loading and stacking containers by cranes. The LD-LRS determines the profile of the container or container stacks, ensuring maximum handling reliability during loading. The automation of the loading process offers great time-saving benefits to the port.

At a glance

- Long range, even when detecting dark objects
- High angular resolution
- High ambient light immunity
- Small light spot diameter
- Up to 4 fields can be programmed

Your benefits

- Optimum installation position on diggers and cranes due to a long scanning range
- High level of reliability, even in poor environmental conditions
- Low installation costs due to large monitoring areas
- Small objects can be reliably detected at long ranges



Additional information

Detailed technical dataD-31
 Ordering informationD-32
 Operating range diagramD-32
 Recommended accessoriesD-33
 Dimensional drawingG-3

→ www.mysick.com/en/LD-LRS

Detailed technical data

Features

Field of application	Indoor, Outdoor (depending on type)
Type	Long Range / Extended Range (depending on type)
Light source	Infrared (905 nm)
Laser class	1, eye-safe (EN/IEC 60825-1)
Field of view	360°
Scanning frequency	5 Hz ... 10 Hz
Angular resolution	0.0625°, 0.125°, 0.25°, 0.5°, 1°, 1.5°
Heating	Yes
Operating range	0.5 m ... 250 m (depending on type)
Max. range with 10 % reflectivity	80 m / 150 m (depending on type)

Performance

Response time	≥ 100 ms
Detectable object shape	Almost any
Systematic error	± 38 mm
Statistical error	± 30 mm
Integrated application	Field evaluation
Number of field sets	4 fields
Simultaneous processing cases	4

Interfaces

Serial (RS-232, RS-422)		✓ (depending on type only RS-232 or RS-422)
	Data transmission rate	4,800 Baud ... 115,200 Baud
Ethernet		✓
	Data transmission rate Protocol	≤ 10 Mbit/s TCP/IP
CAN bus		✓
	Data transmission rate Protocol	10 kbit/s ... 1 Mbit/s Standard 2.0.A
Switching outputs		4 (digital) 1 (digital) 2 (relays) (depending on type)
Optical indicators		4 LED (status display) / 0 (depending on type)

Mechanics/electronics

Electrical connection	1 6-pin terminal block, 15-pin D-Sub HD plug 1 20-pin Harting plug (depending on type)
Operating voltage	24 V DC, ± 15 %
Power consumption	36 W 36 W, + 140 W heating (depending on type)
Housing	Die-cast aluminum / PU (polyurethane rigid integral foam) (depending on type)
Housing color	Light blue (RAL 5012) / gray (RAL 7032) (depending on type)

Enclosure rating	IP 65 / IP 67 (depending on type)
Protection class	III
Weight	4.1 kg / 9.1 kg (depending on type)
Dimensions	118.5 mm x 120.5 mm x 277 mm 250 mm x 350 mm x 391.1 mm (depending on type)

Ambient data

Ambient operating temperature	-25 °C ... +50 °C (depending on type)
Storage temperature	-25 °C ... +80 °C (depending on type)
Permissible relative humidity	85 %, non-condensing

Ordering information

Type	Field of application	Heating	Switching outputs	Housing color	Serial interface	Model name	Part no.
Long Range	Indoor	-	4 (digital)	Light blue (RAL 5012)	RS-232, RS-422	LD-LRS1000	1028941
					RS-232	LD-LRS2100	1029041
	Outdoor	Yes	4 (digital)	Gray (RAL 7032)	RS-422	LD-LRS3100	1029042
					RS-232	LD-LRS4100	1029037
					RS-422	LD-LRS5100	1029038
Extended Range	Outdoor	Yes	4 (digital)	Gray (RAL 7032)	RS-232	LD-LRS2110	1045645
					RS-422	LD-LRS3110	1046011

Operating range diagram



LD-LRS Long Range

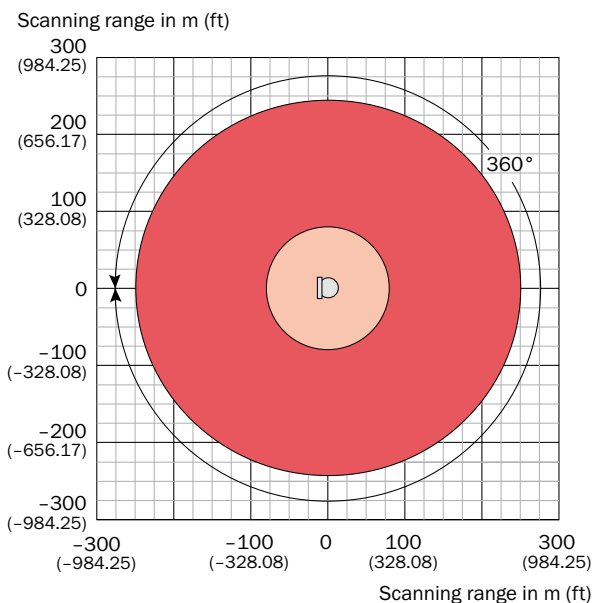

- Scanning range max. 250 m (820.21 ft)
- Scanning range for objects up to 10 % remission 80 m (262.47 ft)

LD-LRS Extended Range

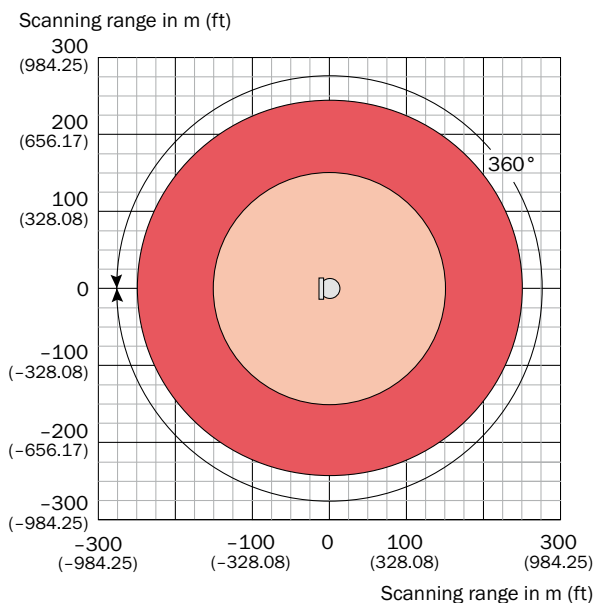

- Scanning range max. 250 m (820.21 ft)
- Scanning range for objects up to 10 % remission 150 m (492.13 ft)

Recommended accessories

Mounting brackets/plates

	Brief description	Part no.	LD-LRS Indoor	LD-LRS Outdoor
	Mounting set (adjustment bracket)	2018303	-	●

Plug connectors and cables

	Brief description	Part no.	LD-LRS Indoor	LD-LRS Outdoor
	CAN cable, 3 m	6032845	●	-
	Cable for parameterization (connection LD-OEMx100 or LD-LRSx1x0 to PC/power supply, RS-232/RS-422/CAN/Ethernet), 3 m	6032770	-	●

Programming/Configuration Tool

	Brief description	Part no.	LD-LRS Indoor	LD-LRS Outdoor
	Scan finder, receiver to localize infrared scans	6020756	●	●

Terminal and alignment brackets

	Brief description	Part no.	LD-LRS Indoor	LD-LRS Outdoor
	Mounting holder, complete with mounting material and tools	5311055	●	-

For additional accessories, please see page F-8

D

Multi-layer scanner for harsh environmental conditions



Product description

The LD-MRS laser scanner is a compact, lightweight, rugged sensor for outdoor automation applications. The LD-MRS is characterized by its reliable, all-weather measuring capabilities. It operates reliably under all weather and light conditions – even in snowy, rainy, dusty or dark conditions. The LD-MRS simultaneously scans and measures objects on four parallel layers, which is

necessary, for example, to compensate for the pitching movements of a vehicle or to determine elevation changes. In addition, up to three successive echos can be detected per measurement and per layer. The LD-MRS is ideal for use in ports, for security functions and in the commercial vehicle segment, e.g., road-cleaning vehicles and for agriculture.

At a glance

- Simultaneous measurement on 4 layers
- Excellent outdoor capabilities with multipulse technology
- Compact and lightweight design. Volume is less than 1 liter, weight is approximately 1 kg
- Wide temperature range with low power consumption: -40 °C to +70 °C at 8 W
- Operation possible even with supply voltages from 9 V DC

Your benefits

- 4-layer laser scanner technology provides reliable, trouble-free detection of objects, even on a slope
- Easy sensor integration due to compact design
- Lower power consumption reduces costs
- Real-time output of measurement data
- IP-69K-rated housing provides accurate measurements in all weather conditions



Additional information

Detailed technical data.....	D-35
Ordering information.....	D-36
Operating range diagram.....	D-36
Recommended accessories.....	D-37

→ www.mysick.com/en/LD-MRS

D

Detailed technical data

Features

	LD-MRS400001	LD-MRS400001S01	LD-MRS400102 HD	LD-MRS400102S01 HD
Field of application	Outdoor			
Type	Long Range			
Laser class	1			
Field of view	85°, operating angle with 4 measurement layers, 25° operating angle expansion with 2 measurement layers (total 110°)			
Scanning frequency	12.5 Hz ... 50 Hz	12.5 Hz ... 50 Hz, object tracking at 12.5 Hz	12.5 Hz ... 50 Hz	12.5 Hz ... 50 Hz, object tracking at 12.5 Hz
Angular resolution	0.125°, 0.25°, 0.5°			
Operating range	0.5 m ... 250 m			
Max. range with 10 % reflectivity	50 m		30 m	
Amount of evaluated echoes	3			

Performance

	LD-MRS400001	LD-MRS400001S01	LD-MRS400102 HD	LD-MRS400102S01 HD
Detectable object shape	Almost any			
Integrated application	Field evaluation	Object tracking	Field evaluation	Object tracking
Number of field sets	16 fields	-	16 fields	-
Simultaneous processing cases	16	-	16	-

Interfaces

	LD-MRS400001	LD-MRS400001S01	LD-MRS400102 HD	LD-MRS400102S01 HD	
Serial (RS-232)	Function	✓ Auxiliary interface			
	Data transmission rate	57,600 Baud			
Ethernet	Function	✓ Raw data interface/parameterization			
	Data transmission rate	100 Mbit/s			
	Protocol	TCP/IP			
CAN bus	Function	✓ Auxiliary interface	✓ Output: Objects, Input: Vehicle ego motion data	✓ Auxiliary interface	✓ Output: Objects, Input: Vehicle ego motion data

Mechanics/electronics

Electrical connection	Circular plug-in connector
Operating voltage	9 V DC ... 27 V DC
Power consumption	8 W
Housing	Al
Housing color	Gray (RAL 7032), black (RAL 9005)
Enclosure rating	IP 69K
Protection class	III
Weight	1 kg
Dimensions	94 mm x 165 mm x 88 mm

Ambient data

Ambient operating temperature	-40 °C ... +70 °C
-------------------------------	-------------------

Ordering information

- **Type:** Long Range
- **Field of application:** Outdoor
- **Housing color:** Gray (RAL 7032), black (RAL 9005)

Model name	Part no.
LD-MRS400001	1045046
LD-MRS400001S01	1052960
LD-MRS400102 HD	1047145
LD-MRS400102S01 HD	1052961

Operating range diagram

LD-MRS400001
LD-MRS400001S01

Scanning range in m (ft)

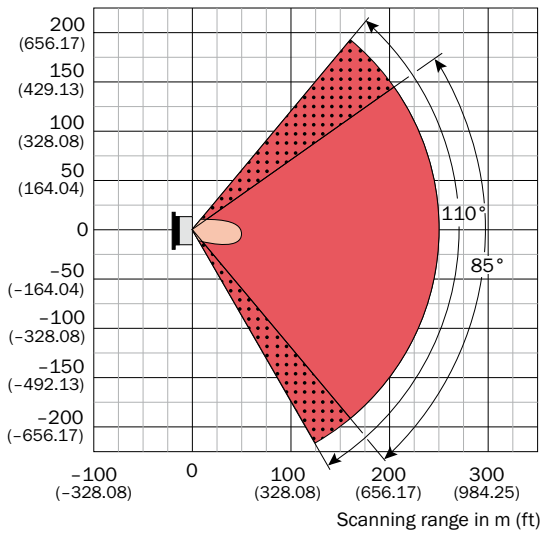

- Scanning range max. 250 m (820.21 ft)
- Scanning range for objects up to 10 % remission 50 m (164.04 ft)
- 2 measuring layers
- 4 measuring layers

LD-MRS400102 HD
LD-MRS400102S01 HD

Scanning range in m (ft)

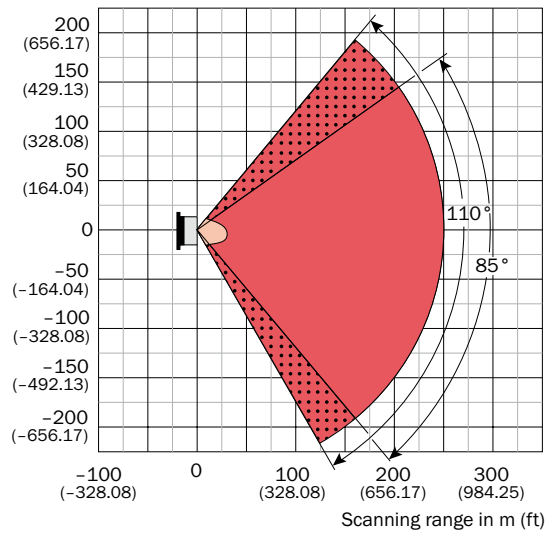

- Scanning range max. 250 m (820.21 ft)
- Scanning range for objects up to 10 % remission 30 m (98.43 ft)
- 2 measuring layers
- 4 measuring layers



D

Recommended accessories

Device protection (mechanical)

	Brief description	Part no.
	Weather hood	2058033

Plug connectors and cables

	Brief description	Part no.
	Connection cable for CAN, 12-pin circular plug/9-pin D-sub plug socket, length 2 m	2054647
	Power supply cable, 4-pin round socket/open end, length 2 m	2049823
	Ethernet data cable (crossover), 4-pin round plug/RJ-45 plug, for connecting Ethernet interface of LD-MRS with Ethernet interface of PC, 2 m	2049826

Programming/Configuration Tool

	Brief description	Part no.
	Scan finder, receiver to localize infrared scans	6020756

Terminal and alignment brackets

	Brief description	Part no.
	Bracket for LD-MRS, alignment adjustable in 2 axes	1047429

For additional accessories, please see page F-8

D



Complete packaged solutions for detection and ranging applications

Complete application packages offer a time-saving solution to your challenges. They are pre-configured to minimize installation and maintenance effort. Since everything is included in the box, the technician can quickly and easily solve the application, whether it's a new task or an expansion to an existing application.

Your benefits

- Fast installation saves time
- Low setup costs
- Low maintenance costs

E



Laser measurement technology application packages

Product family overview E-2



JEF3xx E-4
Simple and fast check of fill levels



JEF5xx E-8
3D measurement with laser – secure and reliable



LMC1xx E-12
Laser Measurement Certified (LMC) – the intelligent way to security



LMP E-16
Pre-configured detection solutions for easy installation in ports





LMS4xx E-18
When accuracy and resolution count





NAV E-22
Navigating the route to improved productivity

E

Product family overview

			
	JEF3xx	JEF5xx	LMC1xx
	Simple and fast check of fill levels	3D measurement with laser – secure and reliable	Laser Measurement Certified (LMC) – the intelligent way to security

Technical data overview			
Field of application	Indoor	Indoor	Indoor / Outdoor/ Security
Field of view	≤ 45°	≤ 45°	270°
Operating range	0.4 m ... 2 m	0.4 m ... 2 m	0.5 m ... 20 m
Max. range with 10 % reflectivity	1.2 m	1.2 m	18 m
Scanning frequency	600 Hz ... 1,000 Hz	600 Hz ... 1,000 Hz	50 Hz
Heating	-	-	Yes
Serial	✓ (RS-232, RS-422/-485)	✓ (RS-232, RS-422/-485)	✓ (RS-232)
Ethernet	✓	✓	✓
CAN bus	-	-	✓
Weight	250 g ... 320 g	250 g ... 320 g	1.1 kg

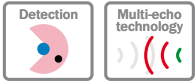
At a glance			
			
	<ul style="list-style-type: none"> • 2D and 3D fill level control • Simple download of new configurations • Multiple I/O and interfacing • Cloning functions for parameters are available 	<ul style="list-style-type: none"> • 2D and 3D laser measurement sensor • Multiple I/O and interfacing • Large working range without any additional focal adjustments • Output of reflectivity data 	<ul style="list-style-type: none"> • The only VdS-certified laser scanner on the market (German certificate standard) • Highest class “C” with environmental class II or IVa • Flexible connection to DC 9 V to 30 V • Two isolated relays (alarms) and one obstruction output • Long detection range of 20 m, horizontal and vertical • Up to 10 freely definable monitoring fields with intelligent evaluation algorithms • Certified QuickStart menu • 200 RAL colors available
Detailed information	→ E-4	→ E-8	→ E-12

E



LMP

Pre-configured detection solutions for easy installation in ports



LMS4xx

When accuracy and resolution count



NAV

Navigating the route to improved productivity

	Outdoor	Indoor	Indoor
	≤ 180° ... ≤ 360°	70°	360°
	0 m ... 250 m	0.7 m ... 3 m	0.5 m ... 250 m, 70 m on reflectors
	-	3 m	35 m
	5 Hz ... 100 Hz	180 Hz ... 500 Hz	5 Hz ... 15 Hz
	Yes	-	-
	-	✓ (RS-232, RS-422)	✓ (RS-232, RS-422)
	-	✓	✓
	-	-	✓ / -
	-	2.3 kg	2.4 kg

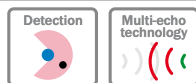

- Fully pre-configured laser measurement sensors for anti-collision tasks
- All necessary accessories are included
- Large operating temperature range from -30° to 50° C
- Wide detection range up to 250 m
- Resistant to maritime climates

→ E-16

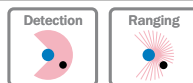

- Level Control, which is integrated into the sensor, features a gap-free scanning surface that can detect objects in containers, without any impairment from a shadow. Smaller objects, regardless of color, are detected at any place in the container.
- Large dynamic measurement range of 0.7 m to 3 m
- High ambient light immunity
- Rugged design
- High angular resolution
- Ideal for vision applications on pallets

→ E-18



- Simple integration via standard interface
- Accurate reflector position measurements
- Navigation with only 3 reflectors
- Immune to unwanted reflections

→ E-22

E

Simple and fast check of fill levels



Product description

JEF3xx is a 2D or 3D laser measurement sensor used to check the fill level of boxes, crates or pallets. The sensor's setup time is reduced by simple con-

figuration download. The reliable laser detection makes additional illumination unnecessary.

At a glance

- 2D and 3D fill level control
- Simple download of new configurations
- Multiple I/O and interfacing
- Cloning functions for parameters are available

Your benefits

- One sensor solution reduces setup costs
- Downloadable configuration options in the machine reduce setup time and save money
- No additional illumination needed



Additional information

- Detailed technical data. E-5
- Ordering information. E-6
- Recommended accessories. E-6

→ www.mysick.com/en/JEF3xx

E

Detailed technical data

Features

Field of application	Indoor
Version	Short Range
Connection type	Ethernet
Reading field	Front / Oscillating mirror (depending on type)
Light source	Visible red light (650 nm)
MTBF	40,000 h
Laser class	2 (EN 60825-1 (A2:2001-03))
Field of view	≤ 45°
Scanning frequency	600 Hz ... 1,000 Hz
Oscillating mirror functions	Oscillating (variable or fixed amplitude)
Oscillation frequency	0.5 Hz ... 6.25 Hz
Angle of deflection	-5° ... 35°
Angular resolution	1°
Operating range	0.4 m ... 2 m
Max. range with 10 % reflectivity	1.2 m

Performance

Response time	≥ 1.4 ms
Detectable object shape	Almost any
Systematic error	± 25 mm
Statistical error	± 25 mm (dependent on remission and distance)
Integrated application	Level Control

Interfaces

Serial (RS-232, RS-422/-485)	Function	✓, AUX (only RS-232) Host, AUX
	Data transmission rate	≥ 2,400 Baud, AUX: 57.6 kBaud
Ethernet	Function	✓ Host, AUX
	Data transmission rate	10/100 Mbit
	Protocol	TCP/IP, half/full-duplex
Switching inputs		2
Switching outputs		2
Optical indicators		6 LEDs (Ready, Laser, Data, CAN, LNK TX)
Connector		Pivotable
Memory card		Micro SD card (flash card) 512 MB, optional

Mechanics/electronics

Electrical connection	2 M12 cylindrical connectors (17-pin plug, 4-pin socket) on swivel connector
Operating voltage	18 V DC ... 30 V DC
Power consumption	8.5 W / 9.5 W (depending on type)
Housing	Die-cast aluminum
Housing color	Light blue (RAL 5012)
Enclosure rating	IP 65 (EN 60529)

¹⁾ Swivel connector is 15 mm longer.

Protection class	III (EN 61140)
Weight	250 g ... 320 g
Dimensions	
Front	61 mm x 96 mm x 38 mm ¹⁾
Oscillating mirror	95 mm x 96 mm x 41 mm ¹⁾

¹⁾ Swivel connector is 15 mm longer.

Ambient data

Electromagnetic compatibility (EMC)	EN 61000G6G2:2001 / EN 61000G6G4:2001
Vibration resistance	EN 60068-2-6 (1995)
Shock resistance	EN 60068-2-27 (1993)
Ambient operating temperature	0 °C ... +40 °C
Storage temperature	-20 °C ... +70 °C
Permissible relative humidity	90 %, non-condensing
Ambient light safety	2,000 lx

Ordering information

Reading field	Model name	Part no.
Front	JEF300-00000	1056363
Oscillating mirror	JEF300-60000	1056364

Recommended accessories



Modules

	Brief description	Model name	Part no.
	Small connection module for one sensor, 4 cable glands, base for CMC600	CDB620-001	1042256

Mounting brackets/plates

	Brief description	Part no.
	Mounting bracket, including installation material	2042800

Plug connectors and cables

	Brief description	Part no.
	Cable, M12 17-pin, to CDB620/CDM420/CDM425/CDF600 15-pin D-sub, 3 m (socket/plug)	2055420
	Ethernet cable, 4-pole, shielded, M12 plug, 4-pin (D-type encoded) / RJ-45 plug, 8-pin, 2 m	6034414

For additional accessories, please see page F-11



3D measurement with laser –
secure and reliable



Product description

JEF5xx is a 2D or 3D laser measurement sensor used for measuring objects and surfaces. With its large working range and opening angle, a pallet can be easily measured with only one sensor. The

laser measurement sensor provides data even in difficult ambient light environments. The reliable laser detection makes additional illumination unnecessary.

At a glance

- 2D and 3D laser measurement sensor
- Multiple I/O and interfacing
- Large working range without any additional focal adjustments
- Output of reflectivity data

Your benefits

- Simple 3D measurement with one sensor
- Large area can be measured with one sensor
- No additional illumination needed



Additional information

- Detailed technical data. E-9
- Ordering information. E-10
- Recommended accessories. E-10

→ www.mysick.com/en/JEF5xx

E

Detailed technical data

Features

Field of application	Indoor
Version	Short Range
Connection type	Ethernet
Reading field	Front / Oscillating mirror (depending on type)
Light source	Visible red light (650 nm)
MTBF	40,000 h
Laser class	2 (EN 60825-1 (A2:2001-03))
Field of view	≤ 45°
Scanning frequency	600 Hz ... 1,000 Hz
Oscillating mirror functions	Oscillating (variable or fixed amplitude)
Oscillation frequency	0.5 Hz ... 6.25 Hz
Angle of deflection	-5° ... 35°
Angular resolution	1°
Operating range	0.4 m ... 2 m
Max. range with 10 % reflectivity	1.2 m

Performance

Response time	≥ 1.125 ms
Detectable object shape	Almost any
Systematic error	± 25 mm
Statistical error	± 25 mm (dependent on remission and distance)

Interfaces

Serial (RS-232, RS-422/-485)	Function	✓, AUX (only RS-232) Host, AUX
	Data transmission rate	2,400 Baud ... 1.15 kBaud, AUX: 57.6 kBaud
Ethernet	Function	✓ Host, AUX
	Data transmission rate	10/100 Mbit
	Protocol	TCP/IP, half/full-duplex
Switching inputs		2
Switching outputs		2
Optical indicators		6 LEDs (Ready, Laser, Data, CAN, LNK TX)
Memory card		Micro SD card (flash card) 512 MB, optional

Mechanics/electronics

Electrical connection	2 M12 cylindrical connectors (17-pin plug, 4-pin socket) on swivel connector
Operating voltage	18 V DC ... 30 V DC
Power consumption	8.5 W / 9.5 W (depending on type)
Housing	Die-cast aluminum
Housing color	Light blue (RAL 5012)
Enclosure rating	IP 65 (EN 60529)

¹⁾ Swivel connector is 15 mm longer.

Protection class	III (EN 61140)
Weight	250 g ... 320 g
Dimensions	
Front	61 mm x 96 mm x 38 mm ¹⁾
Oscillating mirror	95 mm x 96 mm x 41 mm ¹⁾

¹⁾ Swivel connector is 15 mm longer.

Ambient data

Electromagnetic compatibility (EMC)	EN 61000-6-1 (2001-10) / EN 61000-6-2:2005
Vibration resistance	EN 60068-2-6 (1995)
Shock resistance	EN 60068-2-27 (1993)
Ambient operating temperature	0 °C ... +40 °C
Storage temperature	-20 °C ... +70 °C
Permissible relative humidity	90 %, non-condensing
Ambient light safety	2,000 lx

Ordering information

Reading field	Model name	Part no.
Front	JEF500-00000	1056365
Oscillating mirror	JEF500-60000	1056366

Recommended accessories



Modules

	Brief description	Model name	Part no.
	Small connection module for one sensor, 4 cable glands, base for CMC600	CDB620-001	1042256

Mounting brackets/plates

	Brief description	Part no.
	Mounting bracket, including installation material	2042800

Plug connectors and cables

	Brief description	Part no.
	Cable, M12 17-pin, to CDB620/CDM420/CDM425/CDF600 15-pin D-sub, 3 m (socket/plug)	2055420
	Ethernet cable, 4-pole, shielded, M12 plug, 4-pin (D-type encoded) / RJ-45 plug, 8-pin, 2 m	6034414

For additional accessories, please see page F-11



Laser Measurement Certified (LMC) – the intelligent way to security







Detection



Multi-echo technology





Additional information

Detailed technical data..... E-13

Ordering information..... E-14

Operating range diagram E-15

Recommended accessories..... E-15

Product description

The LMC1xx product family is developed for VdS- and VSÖ-compliant security installations according to class “C” (German and Austrian security certificate standard). The LMC consists of a Laser Measurement Certified sensor, a special mounting set and unique, dedicated firmware. The LMC provides protection in all types of environmental and physical mounting configurations (indoor and outdoor). They can be positioned to create a vertical field like a curtain for protecting individual pictures or entire

walls or to create a flat horizontal planar field for protecting ceilings and floors. With several inputs and outputs, the LMC systems can be configured for any situation. For example in a museum, individual paintings can be monitored during the day and the whole wall at night. If the monitored area is breached, an alarm is triggered immediately. The laser sensors can be operated independently or as part of an existing alarm management system due to multiple relay outputs and OPC interface.

At a glance

- The only VdS-certified laser scanner on the market (German certificate standard)
- Highest class “C” with environmental class II or IVa
- Flexible connection to DC 9 V to 30 V
- Two isolated relays (alarms) and one obstruction output
- Long detection range of 20 m, horizontal and vertical
- Up to 10 freely definable monitoring fields with intelligent evaluation algorithms
- Certified QuickStart menu
- 200 RAL colors available

Your benefits

- VdS certification for proven and reliable system acceptance by insurance companies (German certificate standard)
- High angular resolution provides a secure solution that improves reliability
- Secure, reliable detection with few false alarms due to precise field configuration of the detection area
- Small size provides unobtrusive solution
- Intelligent evaluation provides maximum application flexibility
- Easy integration into existing alarm management systems
- Low maintenance due to high immunity against environmental influences
- Cost-effective retrofitting due to low installation and wiring costs

→ www.mysick.com/en/LMC1xx

E

Detailed technical data

Features

	LMC12x	LMC13x
Field of application	Security, Indoor	Security, Outdoor
Type	Short Range	
Light source	Infrared (905 nm)	
Laser class	1 (IEC 60825-1 (2007-3))	
Field of view	270°	
Scanning frequency	50 Hz	
Angular resolution	0.25°, 0.5°	
Heating	-	Yes
Operating range	0.5 m ... 20 m	
Max. range with 10 % reflectivity	18 m	
Amount of evaluated echoes	2	

Performance

Response time	20 ms
Detectable object shape	Almost any
Systematic error	± 30 mm
Statistical error	± 12 mm
Integrated application	Field evaluation
Number of field sets	10 fields
Simultaneous processing cases	10

Interfaces

Serial (RS-232)	Function	✓ Host, AUX
	Data transmission rate	9.6 kBaud ... 115.2 kBaud
Ethernet	Function	✓ Host
	Data transmission rate	10/100 Mbit
	Protocol	TCP/IP
CAN bus	Function	✓ Outputs extension
Switching inputs		4 (2 x IN, 2 x increment (1-phase))
Switching outputs		3 (2 relay, 1 digital)
Optical indicators		1 7-segment display (plus 5 LEDs showing device status, contamination warning and initial condition, both can be activated)

Mechanics/electronics

	LMC12x	LMC13x
Electrical connection	1 system plug with screw terminal block	
Operating voltage	9 V DC ... 30 V DC	
Power consumption	20 W	
Housing color	Gray (RAL 7032) Black (RAL 9005) Signal white (RAL 9003) (depending on type)	

	LMC12x	LMC13x
Enclosure rating	IP 65 (EN 60529, Section 14.2.5)	IP 67 (EN 60529, Section 14.2.5)
Protection class	III (EN 50178 (1997;10))	
Weight	1.1 kg, without connecting cables	
Dimensions	105 mm x 102 mm x 152 mm	

Ambient data

	LMC12x	LMC13x
Object remission	2 % ... > 1,000 % (reflectors)	
Electromagnetic compatibility (EMC)	EN 61000-6-2:2005 / EN 61000-6-4 (2007-01)	
Vibration resistance	EN 60068-2-6 (1995-04)	
Shock resistance	EN 60068-2-27 (1993-03)	
Ambient operating temperature	0 °C ... +50 °C (depending on type)	-30 °C ... +50 °C
Storage temperature	-30 °C ... +70 °C	
Ambient light safety	40,000 lx	

Ordering information

- **Type:** Short Range
- **Switching outputs:** 3 (2 relay, 1 digital)
- **Angular resolution:** 0.25°, 0.5°
- **Object remission:** 2 % ... > 1,000 %, reflectors

Sub product family	Field of application	Heating	Housing color	Items supplied	Model name	Part no.
LMC12x	Security, Indoor	-	Gray (RAL 7032)	LMS12x VdS (indoor), Mounting protection bracket VdS 1 (long)	LMC121-11000 VdS	1051287
				LMS12x VdS (indoor), Mounting protection bracket VdS 2 (short)	LMC121-11001 VdS	1051314
			Black (RAL 9005)	LMS12x VdS (indoor), Mounting protection bracket VdS 1 (long)	LMC122-11000 VdS	1051300
				LMS12x VdS (indoor), Mounting protection bracket VdS 2 (short)	LMC122-11001 VdS	1051315
			Signal white (RAL 9003)	LMS12x VdS (indoor), Mounting protection bracket VdS 1 (long)	LMC123-11000 VdS	1051301
				LMS12x VdS (indoor), Mounting protection bracket VdS 2 (short)	LMC123-11001 VdS	1051316
LMC13x	Security, Outdoor	Yes	Black (RAL 9005)	LMS12x VdS (indoor), Mounting protection bracket VdS 1 (long, uncoated aluminium)	LMC124-11000 VdS	1051303
			Gray (RAL 7032)	LMS13x VdS (outdoor), Mounting protection bracket VdS 2 (short)	LMC131-11101 VdS	1051487
			Black (RAL 9005)		LMC132-11101 VdS	1051488
			Signal white (RAL 9003)		LMC133-11101 VdS	1051489





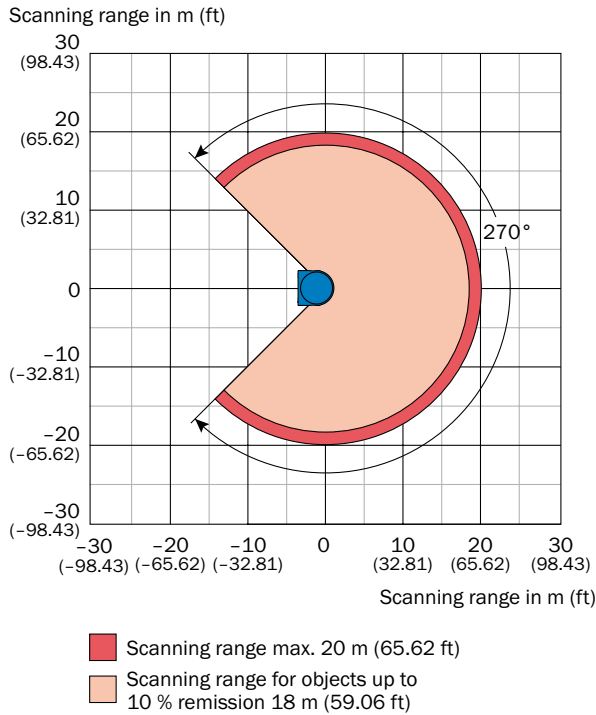

Operating range diagram



Recommended accessories

Plug connectors and cables

	Brief description	Part no.	LMC12x	LMC13x
	I/O connection cable, 8-pole, shielded, M12 plug, 8-pin (A-type encoded) / open end, 5 m	6036155	-	●
	Power supply cable, 4 x 0,50 mm ² , shielded, M12 socket, 5-pin (A-type encoded) / open end, 5 m	6036159	-	●
	Data (RS-232/-422) and synchronization input cable, 8-pole, shielded, M12 socket, 8-pin (A-type encoded) / open end, 5 m	6036153	-	●
	Ethernet cable, 4-pole, shielded, M12 plug, 4-pin (D-type encoded) / RJ-45 plug, 8-pin, 5 m	6034415	●	●

For additional accessories, please see page F-12

E

Pre-configured detection solutions for easy installation in ports

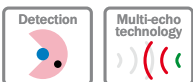

Product description

The LMP application packages consist of laser measurement sensors for detection tasks. These sensors are pre-configured for anti-collision applications on ship-to-

shore cranes. Each package contains the necessary accessories, such as brackets and hoods.

At a glance

- Fully pre-configured laser measurement sensors for anti-collision tasks
- All necessary accessories are included
- Large operating temperature range from -30° to 50° C
- Wide detection range up to 250 m
- Resistant to maritime climates

Your benefits

- Quick and simple commissioning
- Low setup costs
- Easy adaptation to existing infrastructure



Additional information

Detailed technical data..... E-17

Ordering information..... E-17

→ www.mysick.com/en/LMP

E

Detailed technical data

Features

	LMP100	LMP500	LMPLRS
Field of application	Outdoor		
Type	Short Range	Mid Range, Standard Resolution	Long Range
Field of view	≤ 270°	≤ 190°	360°
Scanning frequency	25 Hz / 50 Hz	25 Hz / 35 Hz / 50 Hz / 75 Hz / 100 Hz	5 Hz ... 10 Hz
Heating	Yes		
Operating range	0.5 m ... 20 m	0 m ... 65 m	2.5 m ... 250 m

Performance

	LMP100	LMP500	LMPLRS
Integrated application	Field evaluation		
Number of field sets	10 fields	10 fields	4 fields
Simultaneous processing cases	10	10	4

Mechanics/electronics

Housing color	Gray (RAL 7032)
Enclosure rating	IP 67

Ordering information

- **Field of application:** Outdoor
- **Heating:** yes
- **Housing color:** gray (RAL 7032)

Sub product family	Type	Items supplied	Model name	Part no.
LMP100	Short Range	Kit contains two sensors, I/O cables, power supply cables, weather hoods, brackets, quick release brackets and documentation	LMP100-01	1046577
LMP500	Mid Range, Standard Resolution	Kit contains two sensors, connecting cables (plug-open), connecting cables (socket-open), protection hoods and documentation	LMP500-01	1046578
LMPLRS	Long Range	Kit contains sensor, bracket, carry handle and documentation	LMPLRS-01	1046579

When accuracy and resolution count



Product description

The LMS400 laser measurement system is ideal for material handling and logistics applications where goods must be transported and processed in ever shorter times. The LMS400 offers users a measurement solution that provides high throughput, comprehensive process reliability and improved resolution at close working ranges. The

integrated “Level Control” feature sets new standards for flexibility and application areas in logistics and conveyor systems. Whether in containers, cartons or pallets, the fill level is reliably detected and signaled via integrated switching outputs. The analog output expands the area of use for the direct control of processes in packaging or handling.

At a glance

- Level Control, which is integrated into the sensor, features a gap-free scanning surface that can detect objects in containers, without any impairment from a shadow. Smaller objects, regardless of color, are detected at any place in the container.
- Large dynamic measurement range of 0.7 m to 3 m
- High ambient light immunity
- Rugged design
- High angular resolution
- Ideal for vision applications on pallets

Your benefits

- The integrated Level Control feature replaces a number of sensors and drastically reduces the effort required for wiring and programming
- Reliable detection at high conveyor speeds
- Neither shading nor artificial lighting is necessary
- Simple, flexible installation at positions beyond the robot collision area
- High accuracy detection and positioning measurements in real-time provide rapid data capture



Additional information

Detailed technical data E-19
 Ordering information E-20
 Operating range diagram E-21
 Recommended accessories E-21
 Dimensional drawing G-4

→ www.mysick.com/en/LMS4xx

E

Detailed technical data

Features

Field of application	Indoor
Type	Short Range
Reading field	Front
Light source	Visible red light (650 nm)
Laser class	2
Field of view	70°
Scanning frequency	180 Hz ... 500 Hz (depending on type)
Angular resolution	0.1° ... 1.0°
Operating range	0.7 m ... 3 m
Max. range with 10 % reflectivity	3 m

Performance

Response time	≥ 2 ms
Detectable object shape	Almost any
Systematic error	± 4 mm
Statistical error	± 3 mm (dependent on remission and distance) ± 10 mm (dependent on remission and distance)
Integrated application	Level Control

Interfaces

Serial (RS-232, RS-422)	Function	✓ Host, AUX
Ethernet	Function	✓ Host
	Data transmission rate	10 Mbit, half-duplex
	Protocol	TCP/IP
Switching inputs		4
Switching outputs		5 (4 x PNP / analog 1 x 4 ... 20 mA)
Optical indicators		6 LEDs

Mechanics/electronics

Operating voltage	≤ 24 V DC, ± 15 %
Power consumption	25 W
Housing	Die-cast aluminum
Housing color	Light blue (RAL 5012)
Enclosure rating	IP 20 (DIN 40 050) ¹⁾
Weight	2.3 kg
Dimensions	179 mm x 107 mm x 130 mm

¹⁾ With plug cover IP 65.

Ambient data

Object remission	4.5 % ... 200 % (depending on type)
Electromagnetic compatibility (EMC)	EN 61000G6G2:2001 / EN 61000G6G4:2001
Vibration resistance	EN 60068G2G6, G27, G29, G64
Shock resistance	EN 60068G2G6, G27, G29, G64
Ambient operating temperature	0 °C ... +40 °C
Storage temperature	-20 °C ... +70 °C

General notes

Selectable region of interest (ROI)	From 50 mm x 3,000 mm to 1,000 mm x 1,750 mm
Number of columns	Up to 50 equidistant or 30 freely positionable
Minimum column width	50 mm
Minimum detectable object	30 mm x 30 mm
Smallest height threshold above the container floor	20 mm
Switching threshold output	Telegram, switching outputs or analog output
Output of height values in the columns	Telegram, analog output

Ordering information

- Sub product family: LMS400
- Type: Short Range
- Field of application: Indoor
- Switching outputs: 5 (4 x PNP / analog 1 x 4 ... 20 mA)
- Housing color: light blue (RAL 5012)

Object remission	Model name	Part no.
6.5 % ... 200 %	LMS400-1000	1027897
4.5 % ... 100 %	LMS400-2000	1041725

Operating range diagram

Scanning range in m (ft)

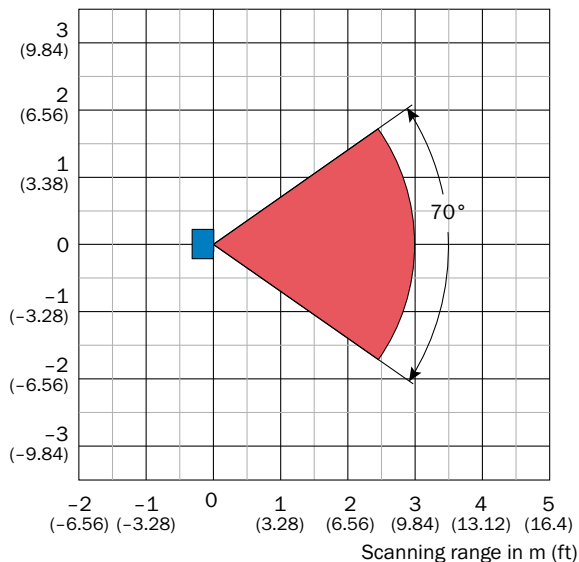





■ Scanning range max. 3 m (9.84 ft)
 Scanning range for objects up to
 10 % remission 3 m (9.84 ft)

Recommended accessories

Modules

	Brief description	Model name	Part no.
	Modular connection module for one sensor	CDM490-0001	1025363

Plug connectors and cables

	Brief description	Part no.
	Connection cable (3 m), Ø 8 mm, shielded, with 15-pin D-sub HD receptacle and 15-pin D-sub HD plug	2020302
	Ethernet cable, for plug hood, Crossover, RJ-45/RJ-45, 10 m	2032821
	Communication cable for connection to the terminal interface of the connector hood set 2031364, 3 m	2031372
	Connection hood, with connection cable 15-pin D-sub, 3 m	2030535

For additional accessories, please see page F-14

E

Navigating the route to improved productivity



Product description

The NAV laser positioning system provides a variety of features that optimize the navigation of automated guided vehicles (AGV). The NAV laser measurement system quickly provides highly precise contour data (distance, angle and reflectivity) and reflector data over 360°. As a result, several measurements on each reflector are automatically calculated to produce an accurate reflector coordi-

nate, making it possible to calculate the vehicle position in the vehicle computer, even when the environmental conditions change. The combination of contour data and reflector data (mixed mode) enable track-guided vehicles to travel in areas where it is not possible to position reflector marks, such as an automatic truck loading or block storage application.

At a glance

- Simple integration via standard interface
- Accurate reflector position measurements
- Navigation with only 3 reflectors
- Immune to unwanted reflections

Your benefits

- Integrated measurement data evaluation reduces the computing effort in vehicle computers, saving time
- Line guidance without reflector marks using the NAV increases application flexibility
- The positioning system allows maximum freedom in the design of the vehicle
- Economical, even for small and medium-sized vehicles
- Simple alteration and teach-in of routes gives users more control over the application
- Accurate positioning measurements, even under harsh environmental conditions



Additional information

Detailed technical data.....	E-23
Ordering information.....	E-24
Operating range diagram.....	E-24
Recommended accessories.....	E-25

→ www.mysick.com/en/NAV

E

Detailed technical data

Features

	NAV300	NAV350
Field of application	Indoor	
Type	Mid Range	
Light source	905 nm	
Laser class	1, eye-safe	
Field of view	360°	
Scanning frequency	5 Hz ... 15 Hz	8 Hz
Angular resolution	0.1°	
Operating range	0.5 m ... 250 m (70 m on reflectors)	
Max. range with 10 % reflectivity	35 m	

Performance

	NAV300	NAV350
Detectable object shape	Almost any	
Systematic error	± 10 mm (RDI) ± 15 mm (Contour)	± 15 mm (Contour)
Statistical error	± 10 mm (RDI) ± 15 mm (Contour)	± 15 mm (Contour)
Reflector memory	-	12,000
Positioning accuracy	-	± 4 mm
Integrated application	Navigation	

Interfaces

	NAV300	NAV350
Serial	✓ (RS-232, RS-422)	✓ (RS-232)
Ethernet	✓	✓
	Data transmission rate Protocol	10 Mbit/s TCP/IP
CAN bus	✓	-
	Data transmission rate	10 bit/s ... 1 Mbit/s
Optical indicators	4 LEDs (status displays)	

Mechanics/electronics

	NAV300	NAV350
Electrical connection	1 6-pin terminal block, 15-pin D-Sub HD plug	1 M12 4-pin plug-in connector
Operating voltage	≥ 24 V DC, ± 15 %	
Power consumption	36 W	
Housing	Die-cast aluminum	
Housing color	Light blue (RAL 5012)	
Enclosure rating	IP 65	IP 54
Protection class	III	
Weight	2.4 kg	
Dimensions	115 mm x 120.5 mm x 222 mm	

Ambient data

Ambient operating temperature	0 °C ... +50 °C
Storage temperature	-20 °C ... +80 °C
Permissible relative humidity	85 %, non-condensing
Reflector marks	Stripes: ≥ 80 mm, cylindrical: diameter ≥ 80 mm

Ordering information

- **Type:** Mid Range
- **Field of application:** Indoor
- **Angular resolution:** 0.1°
- **Housing color:** light blue (RAL 5012)

Sub product family	Model name	Part no.
NAV300	NAV300-2232	1043365
NAV350	NAV350-3232	1052928

Operating range diagram

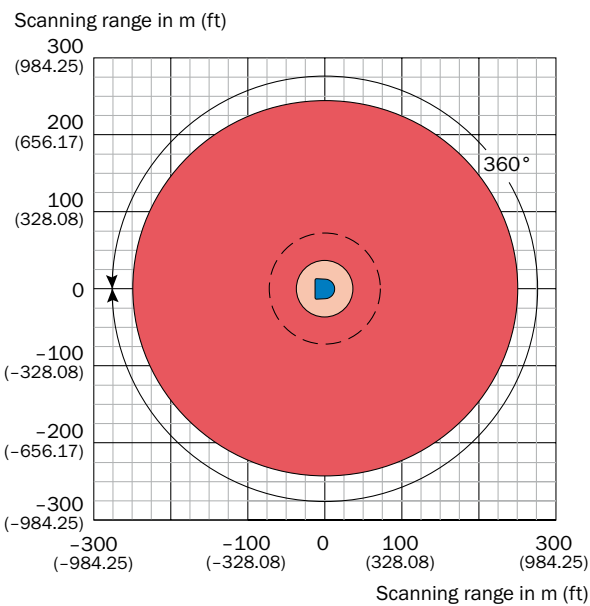





- Scanning range max. 250 m (820.21 ft)
- Scanning range for objects up to 10 % remission 35 m (114.83 ft)
- Scanning range on reflector 70 m (229.66 ft)

E

Recommended accessories

Plug connectors and cables

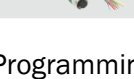
	Brief description	Part no.	NAV300	NAV350
	Cable for parameterization Ethernet crossover, 15-pin D-sub socket / RJ-45 socket, 10 m	6036683	●	-
	Connection cable (RS-232) to PC, 3-wired, with 1 x 9-pin and 1 x 15-pin D-sub socket, 3 m	6032508	●	-
	Power supply cable and sync, M12 x 5, 5 open wires, 5 m	6043440	-	●
	Ethernet cable, 4-pole, shielded, M12 plug, 4-pin (D-type encoded) / RJ-45 plug, 8-pin, 5 m	6034415	-	●
	Data (RS-232/-422) and synchronization input cable, 8-pole, shielded, M12 socket, 8-pin (A-type encoded) / open end, 5 m	6036153	-	●

Programming/Configuration Tool

	Brief description	Part no.	NAV300	NAV350
	Scan finder, receiver to localize infrared scans	6020756	●	●

Reflectors

	Brief description	Part no.	NAV300	NAV350
	Reflective tape (Diamond Grade 983-10), Paper 914 mm x 749 mm	5320565	●	●

Terminal and alignment brackets

	Brief description	Part no.	NAV300	NAV350
	Mounting holder, complete with mounting material and tools	5311055	●	●

For additional accessories, please see page F-15

E



A winning combination: sensors and accessories from SICK

For optimum integration of sensors into your systems, SICK offers a complete range of accessories. This includes everything from connection and mounting systems, to optics cloths and weather hoods.

Reliable signal transmission is paramount for productivity – high-quality connectivity components with long service lives reduce costs. SICK offers perfect connection systems for any application or market, whether for the material handling, packaging, automotive or food and beverage industries. The extensive range of connectors and distributors lets you easily implement the best cabling solution for every application, even under the harshest and most difficult conditions.

With its sophisticated mounting concept, SICK responds to a vast array of sensor installation requirements and offers the right solutions for mounting, alignment and protection of industrial SICK sensor systems. Efficient, and functional.

In addition to the accessories listed in this chapter, please consult your local SICK sales representative for additional country-specific accessories.

F

Product  Finder

www.mysick.com/products

All accessories can be found online: Enter the part no. of the product, and make your selection in “Related content: Accessories.”





Accessories

Laser measurement technology components	F-2
TiM, S100, LMS1xx	F-2
LMS5xx	F-6
LD devices	F-8
Laser measurement technology application packages	F-11
JEF	F-11
LMC1xx	F-12
LMP	F-13
LMS4xx	F-14
NAV.	F-15

TiM, S100, LMS1xx



Adapters/distributors (without cable)

	Brief description	Part no.	TiM31x	S100 Standard	S100 Professional	LMS100	LMS111	LMS12x	LMS13x	LMS151
	M16 EMC-proof cable gland for CANopen connections, permissible cable diameter 3 mm ... 6.5 mm	5318530	-	●	●	-	-	-	-	-
	Adapter for cable entry from M12 to M16	5320690	-	●	●	-	-	-	-	-

Cleaning agent

	Brief description	Part no.	TiM31x	S100 Standard	S100 Professional	LMS100	LMS111	LMS12x	LMS13x	LMS151
	Plastic cleaner and care product, anti-static, 1 liter	5600006	●	●	●	●	●	●	●	●

Device protection (mechanical)



	Brief description	Part no.	TiM31x	S100 Standard	S100 Professional	LMS100	LMS111	LMS12x	LMS13x	LMS151
	Weather hood, 270°	2046458	-	-	-	-	●	-	●	●
	Weather hood, 190°	2046459	-	-	-	-	●	-	●	●

Lens cloths





	Brief description	Part no.	TiM31x	S100 Standard	S100 Professional	LMS100	LMS111	LMS12x	LMS13x	LMS151
	Optics cloth	4003353	-	●	●	●	●	●	●	●

F

Modules

	Brief description	Model name	Part no.	TiM31x	S100 Standard	S100 Professional	LMS100	LMS111	LMS12x	LMS13x	LMS151
	Small connection module for one sensor, 4 cable glands	CDB730-001	1055981	●	-	-	-	-	-	-	-
	External CAN extension module for up to 8 additional outputs (IP 66)	Fieldbus module	6041328	-	-	-	●	●	●	●	●
	External CAN extension module for up to 8 additional outputs	Fieldbus module	6038825	-	-	-	●	●	●	●	●

Mounting brackets/plates

	Brief description	Part no.	TiM31x	S100 Standard	S100 Professional	LMS100	LMS111	LMS12x	LMS13x	LMS151
	Mounting set 2, fender and alignment aid	2061776	●	-	-	-	-	-	-	-
	Standard mounting set for 190°/270° weather hood	2046025	-	-	-	-	●	-	●	●
	Mounting set 1a: bracket for mounting to wall or machine from the back	2034324	-	●	●	●	●	●	●	●
	Mounting set 1b: bracket for mounting to wall or machine from the back, with cover protection	2034325	-	●	●	●	●	●	●	●
	Mounting set 2: bracket, only in combination with bracket 1a or 1b, adjustment possible around transverse axis	2039302	-	●	●	●	●	●	●	●
	Mounting set 3: retention plate, only in combination with bracket 2, adjustment possible around longitudinal axis	2039303	-	●	●	●	●	●	●	●
	Mounting set 3 with vibration absorber, retention plate only in combination with bracket 2, adjustment possible around longitudinal axis	2058723	-	●	●	●	●	●	●	●





Plug connectors and cables

	Brief description	Part no.	TiM31x	S100 Standard	S100 Professional	LMS100	LMS111	LMS12x	LMS13x	LMS151
	Ethernet cable, 4-pole, shielded, M12 plug, 4-pin (D-type encoded) / RJ-45 plug, 8-pin, 5 m	6034415	-	-	-	●	●	●	●	●
	Ethernet cable, 4-pole, shielded, M12 plug, 4-pin (D-type encoded) / RJ-45 plug, 8-pin, 10 m	6030928	-	-	-	●	●	●	●	●
	Ethernet cable, 4-pole, shielded, M12 plug, 4-pin (D-type encoded) / RJ-45 plug, 8-pin, 20 m	6036158	-	-	-	●	●	●	●	●
	I/O connection cable, 8-pole, shielded, M12 plug, 8-pin (A-type encoded) / open end, 5 m	6036155	-	-	-	-	●	-	●	●
	I/O connection cable, 8-pole, shielded, M12 plug, 8-pin (A-type encoded) / open end, 10 m	6036156	-	-	-	-	●	-	●	●
	I/O connection cable, 8-pole, shielded, M12 plug, 8-pin (A-type encoded) / open end, 20 m	6036157	-	-	-	-	●	-	●	●
	Power supply cable, 4 x 0,50 mm ² , shielded, M12 socket, 5-pin (A-type encoded) / open end, 5 m	6036159	-	-	-	-	●	-	●	●
	Power supply cable, 4 x 0,50 mm ² , shielded, M12 socket, 5-pin (A-type encoded) / open end, 10 m	6036160	-	-	-	-	●	-	●	●
	Power supply cable, 4 x 0,50 mm ² , shielded, M12 socket, 5-pin (A-type encoded) / open end, 20 m	6036161	-	-	-	-	●	-	●	●
	Data (RS-232/-422) and synchronization input cable, 8-pole, shielded, M12 socket, 8-pin (A-type encoded) / open end, 5 m	6036153	-	-	-	-	●	-	●	●
	Data (RS-232/-422) and synchronization input cable, 8-pole, shielded, M12 socket, 8-pin (A-type encoded) / open end, 10 m	6028420	-	-	-	-	●	-	●	●
	Data (RS-232/-422) and synchronization input cable, 8-pole, shielded, M12 socket, 8-pin (A-type encoded) / open end, 20 m	6036154	-	-	-	-	●	-	●	●
	USB cable, 2 m	6036106	●	-	-	-	-	-	-	-
	Extension cable, 2 m, 15-wired, shielded, with 15-pin D-sub HD (socket / open end) AWG26	2043413	●	-	-	-	-	-	-	-
	System plug S1xx with one cable gland M16 and one blanking plug M12, on the rear, without cable	2032807	-	●	●	-	-	-	-	-
	System plug S1xx with one cable gland M16 and one blanking plug M12, on the rear, pre-assembled, 5 m long cable, 11 cores	2032859	-	●	-	-	-	-	-	-
	System plug S1xx with one cable gland M16 and one blanking plug M12, on the rear, pre-assembled, 10 m long cable, 11 cores	2032860	-	●	-	-	-	-	-	-
	System plug S1xx with one cable gland M16 and one blanking plug M12, on the rear, pre-assembled, 14 m long cable, 11 cores	2047875	-	●	-	-	-	-	-	-
	System plug S1xx with one cable gland M16 and one blanking plug M12, on the rear, pre-assembled, 20 m long cable, 11 cores	2032861	-	●	-	-	-	-	-	-
	System plug S1xx with one cable gland M16 and one blanking plug M12, on the rear, pre-assembled, 5 m long cable, 15 cores	2034264	-	-	●	-	-	-	-	-
	System plug S1xx with one cable gland M16 and one blanking plug M12, on the rear, pre-assembled, 10 m long cable, 15 cores	2034265	-	-	●	-	-	-	-	-
	Parameter setting cable for PC connection (9-pin Sub-D) to CDF600 (4-pin M8), 2 m	6021195	-	●	●	●	●	●	●	●
	Parameter setting cable for PC connection (9-pin Sub-D) to CDF600 (4-pin M8), 10 m	2027649	-	●	●	●	●	●	●	●
	Cable 15-pin, wire cross-section 0.56 mm ² (AWG 20), on 100 m reel	6030795	-	●	●	●	-	●	-	-
	CANopen cable, sold by meter (2 x 2 x 0.22 mm ²)	6035263	-	●	●	-	-	-	-	-

F

Power supply units

	Brief description	Part no.	TiM31x	S100 Standard	S100 Professional	LMS100	LMS111	LMS12x	LMS13x	LMS151
	Power supply DC 24 V / 4 A	6010362	-	●	●	●	●	●	●	●
	Power supply DC 24 V / 2,5 A	6022427	-	●	●	●	●	●	●	●
	Power supply DC 24 V / 10 A	6020875	-	●	●	●	●	●	●	●

Programming/Configuration tool

	Brief description	Part no.	TiM31x	S100 Standard	S100 Professional	LMS100	LMS111	LMS12x	LMS13x	LMS151
	Scan finder, receiver to localize infrared scans	6020756	-	●	●	●	●	●	●	●

Software

	Model name	Part no.	TiM31x	S100 Standard	S100 Professional	LMS100	LMS111	LMS12x	LMS13x	LMS151
	CDS-S100	2042818	-	●	●	-	-	-	-	-

Terminal and alignment brackets

	Brief description	Part no.	TiM31x	S100 Standard	S100 Professional	LMS100	LMS111	LMS12x	LMS13x	LMS151
	Rapid-release mounting set for 190°/270° weather hood	2046989	-	-	-	-	●	-	●	●



LMS5xx





Device protection (mechanical)

Brief description	Part no.	LMS500 Lite	LMS500 PRO	LMS511 Lite	LMS511 PRO	LMS531 Lite
Protection hood	2056850	-	-	●	●	●



Lens cloths

Brief description	Part no.	LMS500 Lite	LMS500 PRO	LMS511 Lite	LMS511 PRO	LMS531 Lite
 Optics cloth	4003353	●	●	●	●	●







Mounting brackets/plates

Brief description	Part no.	LMS500 Lite	LMS500 PRO	LMS511 Lite	LMS511 PRO	LMS531 Lite
Mounting bracket for LMS5xx (for retrofitting, if 2018303 is already in use)	2059271	●	●	●	●	●
 Mounting set with two axes, fine adjustable (basic equipment)	2020925	●	●	●	●	●
 Mounting set 1	2015623	●	●	●	●	●
 Mounting set 2	2015624	●	●	●	●	●
 Mounting set 3 (Mounting sets 1+2 additionally necessary)	2015625	●	●	●	●	●



Other mounting accessories

Brief description	Part no.	LMS500 Lite	LMS500 PRO	LMS511 Lite	LMS511 PRO	LMS531 Lite
 Extension for mounting set 2015925 (3rd axis)	2020926	●	●	●	●	●
 Strap for mast bracket (sold by meter)	5306222	●	●	●	●	●
 Strap lock	5306221	●	●	●	●	●

Plug connectors and cables

	Brief description	Part no.	LMS500 Lite	LMS500 PRO	LMS511 Lite	LMS511 PRO	LMS531 Lite
	Ethernet cable, 4-pole, shielded, M12 plug, 4-pin (D-type encoded) / RJ-45 plug, 8-pin, 5 m	6034415	●	●	●	●	●
	Ethernet cable, 4-pole, shielded, M12 plug, 4-pin (D-type encoded) / RJ-45 plug, 8-pin, 10 m	6030928	●	●	●	●	●
	Ethernet cable, 4-pole, shielded, M12 plug, 4-pin (D-type encoded) / RJ-45 plug, 8-pin, 20 m	6036158	●	●	●	●	●
	USB cable, 4-pole, shielded, plug type mini B / plug type A, 3 m	6042517	●	●	●	●	●
	Data (RS-232/-422) and I/O connection cable, 12-pole, shielded, M12 socket, 12-pin (A-type encoded) / open end, 5 m	6042735	-	-	-	●	-
	Data (RS-232/-422) and I/O connection cable, 12-pole, shielded, M12 socket, 12-pin (A-type encoded) / open end, 10 m	6042736	-	-	-	●	-
	Data (RS-232/-422) and I/O connection cable, 12-pole, shielded, M12 socket, 12-pin (A-type encoded) / open end, 20 m	6042737	-	-	-	●	-
	I/O connection cable, 12-pole, shielded, M12 plug, 12-pin (A-type encoded) / open end, 5 m	6042732	-	-	-	●	-
	I/O connection cable, 12-pole, shielded, M12 plug, 12-pin (A-type encoded) / open end, 10 m	6042733	-	-	-	●	-
	I/O connection cable, 12-pole, shielded, M12 plug, 12-pin (A-type encoded) / open end, 20 m	6042734	-	-	-	●	-
	Data (RS-232/-422) and synchronization input cable, 8-pole, shielded, M12 socket, 8-pin (A-type encoded) / open end, 5 m	6036153	-	-	●	-	●
	Data (RS-232/-422) and synchronization input cable, 8-pole, shielded, M12 socket, 8-pin (A-type encoded) / open end, 10 m	6028420	-	-	●	-	●
	Data (RS-232/-422) and synchronization input cable, 8-pole, shielded, M12 socket, 8-pin (A-type encoded) / open end, 20 m	6036154	-	-	●	-	●
	I/O connection cable, 8-pole, shielded, M12 plug, 8-pin (A-type encoded) / open end, 5 m	6036155	-	-	●	-	●
	I/O connection cable, 8-pole, shielded, M12 plug, 8-pin (A-type encoded) / open end, 10 m	6036156	-	-	●	-	●
	I/O connection cable, 8-pole, shielded, M12 plug, 8-pin (A-type encoded) / open end, 20 m	6036157	-	-	●	-	●
	Power supply cable, 4 x 0,50 mm ² , shielded, M12 socket, 5-pin (A-type encoded) / open end, 5 m	6036159	-	-	●	●	●
	Power supply cable, 4 x 0,75 mm ² , shielded, M12 socket, 5-pin (A-type encoded) / open end, 10 m	6042565	-	-	●	●	●
	Power supply cable, 4 x 0,75 mm ² , shielded, M12 socket, 5-pin (A-type encoded) / open end, 20 m	6042564	-	-	●	●	●

Power supply units

	Brief description	Part no.	LMS500 Lite	LMS500 PRO	LMS511 Lite	LMS511 PRO	LMS531 Lite
	Power supply DC 24 V / 4 A	6010362	●	●	●	●	●
	Power supply DC 24 V / 2,5 A	6022427	●	●	●	●	●
	Power supply DC 24 V / 10 A	6020875	●	●	●	●	●

Programming/Configuration tool

	Brief description	Part no.	LMS500 Lite	LMS500 PRO	LMS511 Lite	LMS511 PRO	LMS531 Lite
	Scan finder, receiver to localize infrared scans	6020756	●	●	●	●	●

Software

	Brief description	Part no.	LMS500 Lite	LMS500 PRO	LMS511 Lite	LMS511 PRO	LMS531 Lite
	DVD manuals & software	2039442	●	●	●	●	●

Terminal and alignment brackets

	Brief description	Part no.	LMS500 Lite	LMS500 PRO	LMS511 Lite	LMS511 PRO	LMS531 Lite
	Pole bracket (additionally required: adapter bracket 2059271 for LMS5xx / mounting set 2018303 for LD-LRS)	2018304	●	●	●	●	●

LD devices

Adapters/distributors (without cable)

	Brief description	Part no.	LD-OEM Indoor	LD-LRS Indoor	LD-LRS Outdoor	LD-MRS Outdoor
	CAN termination	6042511	-	-	-	●

Cleaning agent

	Brief description	Part no.	LD-OEM Indoor	LD-LRS Indoor	LD-LRS Outdoor	LD-MRS Outdoor
	Plastic cleaner and care product, anti-static, 1 liter	5600006	-	●	●	●



Device protection (mechanical)

	Brief description	Part no.	LD-OEM Indoor	LD-LRS Indoor	LD-LRS Outdoor	LD-MRS Outdoor
	Weather hood	2058033	-	-	-	●

Lens cloths

	Brief description	Part no.	LD-OEM Indoor	LD-LRS Indoor	LD-LRS Outdoor	LD-MRS Outdoor
	Optics cloth	4003353	●	●	●	●



Modules

	Brief description	Part no.	LD-OEM Indoor	LD-LRS Indoor	LD-LRS Outdoor	LD-MRS Outdoor
	External CAN extension module for up to 8 additional outputs (IP 66)	6041328	-	-	-	●
	External CAN extension module for up to 8 additional outputs	6038825	-	-	-	●













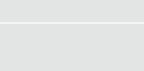

Mounting brackets/plates

	Brief description	Part no.	LD-OEM Indoor	LD-LRS Indoor	LD-LRS Outdoor	LD-MRS Outdoor
	Mounting set (adjustment bracket)	2018303	-	-	●	-

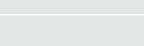
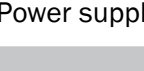
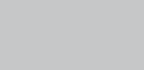

Other mounting accessories

	Brief description	Part no.	LD-OEM Indoor	LD-LRS Indoor	LD-LRS Outdoor	LD-MRS Outdoor
	Strap for mast bracket (sold by meter)	5306222	-	-	●	-
	Strap lock	5306221	-	-	●	-

Plug connectors and cables

	Brief description	Part no.	LD-OEM Indoor	LD-LRS Indoor	LD-LRS Outdoor	LD-MRS Outdoor
	Cable splitter 1:3, 12-pin round plug on 9-pin D Sub plug (synchronization), 9-pin D Sub socket (RS-232) and 9-pin D Sub socket (CAN, reserved), 2 m	2049831	-	-	-	●
	Connection cable for CAN, 12-pin circular plug / 9-pin D-sub plug socket, length 8 m	2054648	-	-	-	●
	Connection cable for CAN, 12-pin circular plug / 9-pin D-sub plug socket, length 2 m	2054647	-	-	-	●
	Connection cable for synchronization, 12-pin round plug / 9-pin D Sub plug, length 2 m	2049829	-	-	-	●
	Connection cable for synchronization, 12-pin round plug / 9-pin D Sub plug, length 8 m	2049830	-	-	-	●
	Power supply cable, 4-pin round socket / open end, length 2 m	2049823	-	-	-	●
	Power supply cable, 4-pin round socket / open end, length 8 m	2049824	-	-	-	●
	Power supply cable, 4-pin round socket / open end, length 20 m	2049825	-	-	-	●
	Extension cable for RS-232 data interface and synchronization, 12-pin round plug/socket, length 8 m	2049832	-	-	-	●
	Ethernet data cable (crossover), 4-pin round plug / RJ-45 plug, for connecting Ethernet interface of LD-MRS with Ethernet interface of PC, 2 m	2049826	-	-	-	●
	Ethernet data cable (crossover), 4-pin round plug / RJ-45 plug, for connecting Ethernet interface of LD-MRS with Ethernet interface of PC, 8 m	2049827	-	-	-	●
	Ethernet data cable (crossover), 4-pin round plug / RJ-45 plug, for connecting Ethernet interface of LD-MRS with Ethernet interface of PC, 20 m	2049828	-	-	-	●
	CAN cable, 3 m	6032845	●	●	-	-
	Connection cable (RS-232) to PC, 3-wired, with 1 x 9-pin and 1 x 15-pin D-sub socket, 3 m	6032508	●	●	-	-
	Ethernet cable, 15-pin D-sub socket / RJ-45 socket, 3 m	6032509	●	●	-	-
	Cable for parameter setting Ethernet crossover, 15-pin D-sub socket/RJ-45 socket, 10 m	6036683	●	●	-	-
	Cable for parameter setting (connection LD-OEMx100 or LD-LRSx1x0 to PC / power supply, RS-232/RS-422/CAN/Ethernet), 3 m	6032770	-	-	●	-
	Connection plug for LD-LRS2100/LD-LRS3100 (included in scope of delivery)	2039025	-	-	●	-

Power supply units

	Brief description	Part no.	LD-OEM Indoor	LD-LRS Indoor	LD-LRS Outdoor	LD-MRS Outdoor
	Power supply DC 24 V / 4 A	6010362	●	●	-	●
	Power supply DC 24 V / 2,5 A	6022427	●	●	-	●
	Power supply DC 24 V / 10 A	6020875	●	●	●	●

F

Programming/Configuration tool

	Brief description	Part no.	LD-OEM Indoor	LD-LRS Indoor	LD-LRS Outdoor	LD-MRS Outdoor
	Scan finder, receiver to localize infrared scans	6020756	●	●	●	●

Terminal and alignment brackets



	Brief description	Part no.	LD-OEM Indoor	LD-LRS Indoor	LD-LRS Outdoor	LD-MRS Outdoor
	Pole bracket (additionally required: adapter bracket 2059271 for LMS5xx / mounting set 2018303 for LD-LRS)	2018304	-	-	●	-
	Bracket for LD-MRS, alignment adjustable in 2 axes	1047429	-	-	-	●
	Mounting holder, complete with mounting material and tools	5311055	●	●	-	-

Application packages JEF



Modules

	Brief description	Model name	Part no.	JEF300	JEF500
	Small connection module for one sensor, 4 cable glands, base for CMC600	CDB620-001	1042256	●	●

Mounting brackets/plates

	Brief description	Part no.	JEF300	JEF500
	Mounting bracket with integrated vibration/shock absorber for mounting the scanner e. g., on a forklift	2042799	●	●
	Mounting bracket, including installation material	2042800	●	●

Plug connectors and cables

	Brief description	Part no.	JEF300	JEF500
	Ethernet cable, 4-pole, shielded, M12 plug, 4-pin (D-type encoded) / RJ-45 plug, 8-pin, 2 m	6034414	●	●
	Ethernet cable, 4-pole, shielded, M12 plug, 4-pin (D-type encoded) / RJ-45 plug, 8-pin, 5 m	6034415	●	●
	Ethernet cable, 4-pole, shielded, M12 plug, 4-pin (D-type encoded) / RJ-45 plug, 8-pin, 10 m	6030928	●	●
	Ethernet cable, 4-pole, shielded, M12 plug, 4-pin (D-type encoded) / M12 plug, 4-pin (D-type encoded), 2 m	6034420	●	●
	Ethernet cable, 4-pole, shielded, M12 plug, 4-pin (D-type encoded) / M12 plug, 4-pin (D-type encoded), 3 m	6034421	●	●
	Ethernet cable, 4-pole, shielded, M12 plug, 4-pin (D-type encoded) / M12 plug, 4-pin (D-type encoded), 5 m	6034422	●	●
	Ethernet cable, 4-pole, shielded, drag-chain compliant, M12 plug, 4-pin (D-type encoded) / RJ-45 plug, 8-pin, 3 m	6029630	●	●
	Cable, M12 17-pin, to CDB620/CDM420/CDM425/CDF600 15-pin D-sub, 2 m (socket/plug)	2055419	●	●
	Cable, M12 17-pin, to CDB620/CDM420/CDM425/CDF600 15-pin D-sub, 3 m (socket/plug)	2055420	●	●
	Cable, M12 17-pin, to CDB620/CDM420/CDM425/CDF600 15-pin D-sub, 0.9 m (socket/plug)	2049764	●	●

Terminal and alignment brackets

	Brief description	Part no.	JEF300	JEF500
	Round rod bracket	2042801	●	●

Application packages LMC1xx

Cleaning agent

	Brief description	Part no.	LMC12x	LMC13x
	Plastic cleaner and care product, anti-static, 1 liter	5600006	●	●

Lens cloths





	Brief description	Part no.	LMC12x	LMC13x
	Optics cloth	4003353	●	●

F



Mounting brackets/plates

	Brief description	Part no.	LMC12x	LMC13x
	Mounting set VdS 1, uncoated	2056272	●	●
	Mounting set VdS 1, RAL 9005	2056271	●	●
	Mounting set VdS 1, RAL 9003	2052396	●	●
	Mounting set VdS 1, RAL 7032	2056270	●	●

Plug connectors and cables

	Brief description	Part no.	LMC12x	LMC13x
	Ethernet cable, 4-pole, shielded, M12 plug, 4-pin (D-type encoded) / RJ-45 plug, 8-pin, 5 m	6034415	●	●
	Ethernet cable, 4-pole, shielded, M12 plug, 4-pin (D-type encoded) / RJ-45 plug, 8-pin, 10 m	6030928	●	●
	Ethernet cable, 4-pole, shielded, M12 plug, 4-pin (D-type encoded) / RJ-45 plug, 8-pin, 20 m	6036158	●	●
	I/O connection cable, 8-pole, shielded, M12 plug, 8-pin (A-type encoded) / open end, 5 m	6036155	-	●
	I/O connection cable, 8-pole, shielded, M12 plug, 8-pin (A-type encoded) / open end, 10 m	6036156	-	●
	I/O connection cable, 8-pole, shielded, M12 plug, 8-pin (A-type encoded) / open end, 20 m	6036157	-	●
	Data (RS-232/-422) and synchronization input cable, 8-pole, shielded, M12 socket, 8-pin (A-type encoded) / open end, 5 m	6036153	-	●
	Data (RS-232/-422) and synchronization input cable, 8-pole, shielded, M12 socket, 8-pin (A-type encoded) / open end, 10 m	6028420	-	●
	Data (RS-232/-422) and synchronization input cable, 8-pole, shielded, M12 socket, 8-pin (A-type encoded) / open end, 20 m	6036154	-	●
	Power supply cable, 4 x 0,50 mm ² , shielded, M12 socket, 5-pin (A-type encoded) / open end, 5 m	6036159	-	●
	Power supply cable, 4 x 0,50 mm ² , shielded, M12 socket, 5-pin (A-type encoded) / open end, 20 m	6036161	-	●
	Power supply cable, 4 x 0,50 mm ² , shielded, M12 socket, 5-pin (A-type encoded) / open end, 10 m	6036160	-	●

Power supply units

	Brief description	Part no.	LMC12x	LMC13x
	Power supply DC 24 V / 4 A	6010362	●	●
	Power supply DC 24 V / 10 A	6020875	●	●
	Power supply DC 24 V / 2,5 A	6022427	●	●

Programming/Configuration tool

	Brief description	Part no.	LMC12x	LMC13x
	Scan finder, receiver to localize infrared scans	6020756	●	●

Application packages LMP

Plug connectors and cables



	Brief description	Part no.	LMP100	LMP500	LMPLRS
	Ethernet cable, 4-pole, shielded, M12 plug, 4-pin (D-type encoded) / RJ-45 plug, 8-pin, 20 m	6036158	●	-	-
	Ethernet cable, 4-pole, shielded, M12 plug, 4-pin (D-type encoded) / RJ-45 plug, 8-pin, 5 m	6034415	-	●	-
	Data (RS-232/-422) and I/O connection cable, 12-pole, shielded, M12 socket, 12-pin (A-type encoded) / open end, 5 m	6042735	-	●	-
	Cable for parameter setting (connection LD-OEMx100 or LD-LRSx1x0 to PC / power supply, RS-232/RS-422/CAN/Ethernet), 3 m	6032770	-	-	●

Application packages LMS4xx











Lens cloths

	Brief description	Part no.	LMS400
	Optics cloth	4003353	●

Modules



	Brief description	Model name	Part no.	LMS400
	Modular connection module for one sensor	CDM490-0001	1025363	●
	Modular connection module for one sensor, Host and AUX interface available on face plate	CDM490-0101	1025365	●

Plug connectors and cables

	Brief description	Part no.	LMS400
	Ethernet-cable, for plug hood, Crossover, RJ-45/RJ-45, 10 m	2032821	●
	Ethernet-cable, for plug hood, RJ-45/RJ-45, 10 m	2030467	●
	Ethernet-cable, flexible for plug hood, RJ-45/RJ-45, 10 m	2034673	●
	Ethernet-cable, flexible for plug hood, Crossover, RJ-45/RJ-45, 10 m	2034675	●
	Synchronization cable for plug hood, 3 m	2030451	●
	Ethernet crossover cable 2 x RJ-45	6026084	●
	Connection cable (3 m), Ø 8 mm, shielded, with 15-pin D-sub HD receptacle and 15-pin D-sub HD plug	2020302	●
	Communication cable for connection to the terminal interface of the connector hood set 2031364, 3 m	2031372	●
	Data connection cable (RS-232) for LMS/CDM490-0101 to PC, with 2 x 9-pin D-sub socket/plug	2013568	●
	Connection hood, IP 65	2030439	●
	Connection hood, with connection cable 15-pin D-sub, 3 m	2030535	●

F

Power supply units

	Brief description	Part no.	LMS400	
	Power supply DC 24 V / 4 A	6010362	●	
	Power supply DC 24 V / 2,5 A	6022427	●	
	Power supply DC 24 V / 10 A	6020875	●	

Terminal and alignment brackets

	Brief description	Part no.	LMS400	
	Holder for item profile	2030421	●	

Application packages NAV

Cleaning agent





	Brief description	Part no.	NAV300	NAV350
	Plastic cleaner and care product, anti-static, 1 liter	5600006	●	●

Lens cloths

	Brief description	Part no.	NAV300	NAV350
	Optics cloth	4003353	●	●

Plug connectors and cables

	Brief description	Part no.	NAV300	NAV350
	Ethernet cable, 15-pin D-sub socket / RJ-45 socket, 3 m	6032509	●	-

	Brief description	Part no.	NAV300	NAV350
	Cable for parameter setting Ethernet crossover, 15-pin D-sub socket/RJ-45 socket, 10 m	6036683	●	-
	Connection cable (RS-232) to PC, 3-wired, with 1 x 9-pin and 1 x 15-pin D-sub socket, 3 m	6032508	●	-
	Ethernet cable, 4-pole, shielded, M12 plug, 4-pin (D-type encoded) / RJ-45 plug, 8-pin, 5 m	6034415	-	●
	Ethernet cable, 4-pole, shielded, M12 plug, 4-pin (D-type encoded) / RJ-45 plug, 8-pin, 10 m	6030928	-	●
	Data (RS-232/-422) and synchronization input cable, 8-pole, shielded, M12 socket, 8-pin (A-type encoded) / open end, 5 m	6036153	-	●
	Data (RS-232/-422) and synchronization input cable, 8-pole, shielded, M12 socket, 8-pin (A-type encoded) / open end, 10 m	6028420	-	●
	Power supply cable, 4 x 0,50 mm ² , shielded, M12 socket, 5-pin (A-type encoded) / open end, 5 m	6036159	-	●
	Power supply cable, 4 x 0,50 mm ² , shielded, M12 socket, 5-pin (A-type encoded) / open end, 10 m	6036160	-	●
	Power supply cable, 4 x 0,50 mm ² , shielded, M12 socket, 5-pin (A-type encoded) / open end, 20 m	6036161	-	●
	Power supply cable and sync, M12 x 5, 5 open wires, 5 m	6043440	-	●

Power supply units

	Brief description	Part no.	NAV300	NAV350
	Power supply DC 24 V / 4 A	6010362	●	●
	Power supply DC 24 V / 10 A	6020875	●	●

Programming/Configuration tool

	Brief description	Part no.	NAV300	NAV350
	Scan finder, receiver to localize infrared scans	6020756	●	●

Reflectors

	Brief description	Model name	Part no.	NAV300	NAV350
	Reflective tape (Diamond Grade 983-10), paper 914 mm x 749 mm	REF-DG	5320565	●	●

F

Terminal and alignment brackets

	Brief description	Part no.	NAV300	NAV350
	Mounting holder, complete with mounting material and tools	5311055	●	●





Free CAD downloads at www.mysick.com

For every device, we provide all popular 2D and 3D CAD models at our online Partner Portal www.mysick.com.

SICK Sensor Intelligence. Startseite | SICK Gruppe | Anmelden | Deutsch | Partner Portal

Produkte | Service & Support

Produktfinder | Applikationsfinder | Ersatzteile

Produktsuche

Change Language: English

Product Finder: Industrial Sensors, Registration Sensors, Distance Sensors

Bar Code Scanners

CLV6Sx / CLV6S1 / Low Density

Model Name: CLV6S1-6120
Part No.: 1046560

At a glance: Huge depth of field due to Autofocus

CAD Downloads

Bar Code Scanners > CLV60-6120 > Ethernet

Visualization Formats	Viewing Software
Preview directly in your browser [Requires JavaScript]	Autodesk 3D Viewer
CLV6Sx_64_65a-6120-8027501.pdf [4.07 MB] 3D Preview in Portable Document File [PDF]	Adobe Acrobat Reader
CLV6Sx_64_65a-6120-8027501.iam [0.86 MB] Solid Works eDrawing	Solid Works eDrawings Viewer
2-Dimensional Formats	Viewing Software
CLV6Sx_64_65a-6120-8112300.dwg [5.34 MB] AutoCAD Drawing Interchange Format	Solid Works eDrawings Viewer
3-Dimensional Formats	Viewing Software
CLV6Sx_64_65a-6120-8027501.stp [7.36 MB] STEP Standard [ISO 10303]	CATIA v4 Pro / ENGINEER™ Dassault Systèmes
CLV6Sx_64_65a-6120-8027501.sas [5.97 MB] Spatial ACIS SAT 3.0	3D ACIS Modeling Inventor Autodesk
CLV6Sx_64_65a-6120-8027501_ww_x_1 [8.07 MB] Parasolid Team Transact Format	Solid Works Unigraphics NX Siemens
CLV6Sx_64_65a-6120-8027501.png [2.82 MB] CoCreate OneSpace.net Designer Package	PTC CoCreate Modeler
CLV6Sx_64_65a-6120-8027501.igs [12.51 MB] IGES Standard - Initial Graphics Exchange Specification	CATIA v4 Pro / ENGINEER™ Dassault Systèmes
CLV6Sx_64_65a-6120-8027501.amf_gzip [1.44 MB] Advanced Model File [AMF] v. Pro / ENGINEER™	OneSpace.net + PTC Pro / ENGINEER™ Autodesk

Bild anzeigen
 Online data sheet
 Seiten-URL kopieren
 Link versenden
 Leszeichen erstellen

Literature
 Product information
 Operating instructions
 more...

Info service
 Dimensional drawing
 Reading field diagram
 Configuration software
 CAD design models

Related content
 Accessories

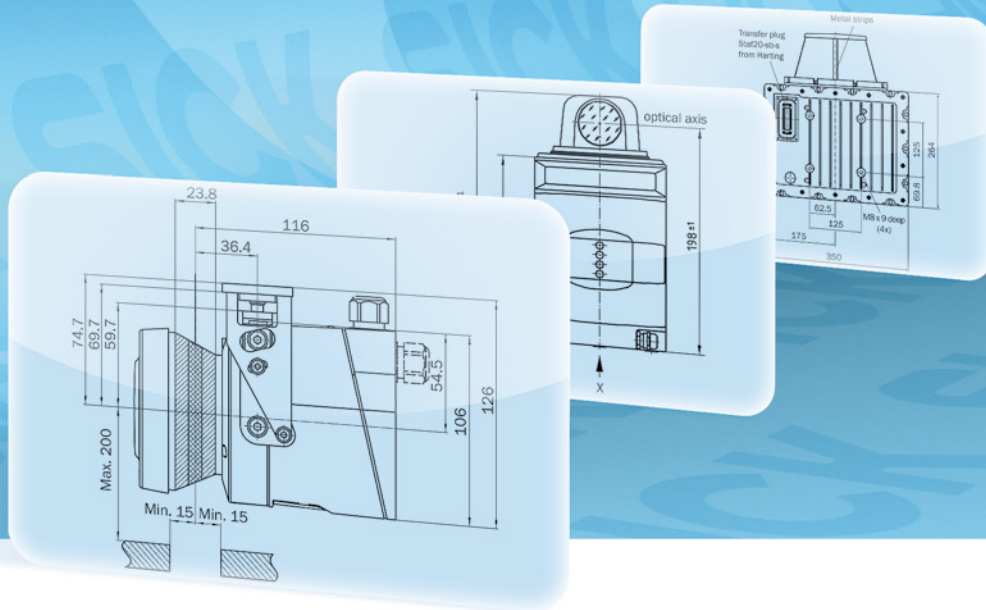

Dimensional drawings

Laser measurement technology components G-2

Laser measurement technology application packages G-4

Laser measurement technology components

→ Additional 2D and 3D CAD models available to download free-of-charge at www.mysick.com

S100

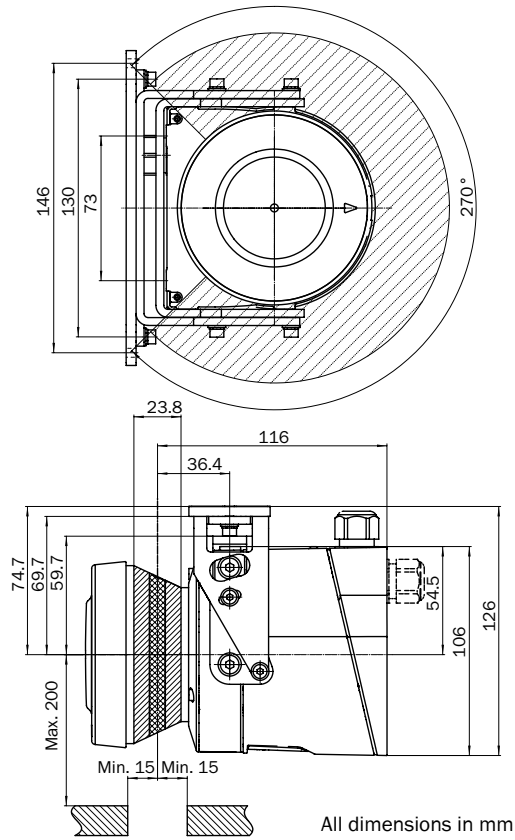

LD-OEM

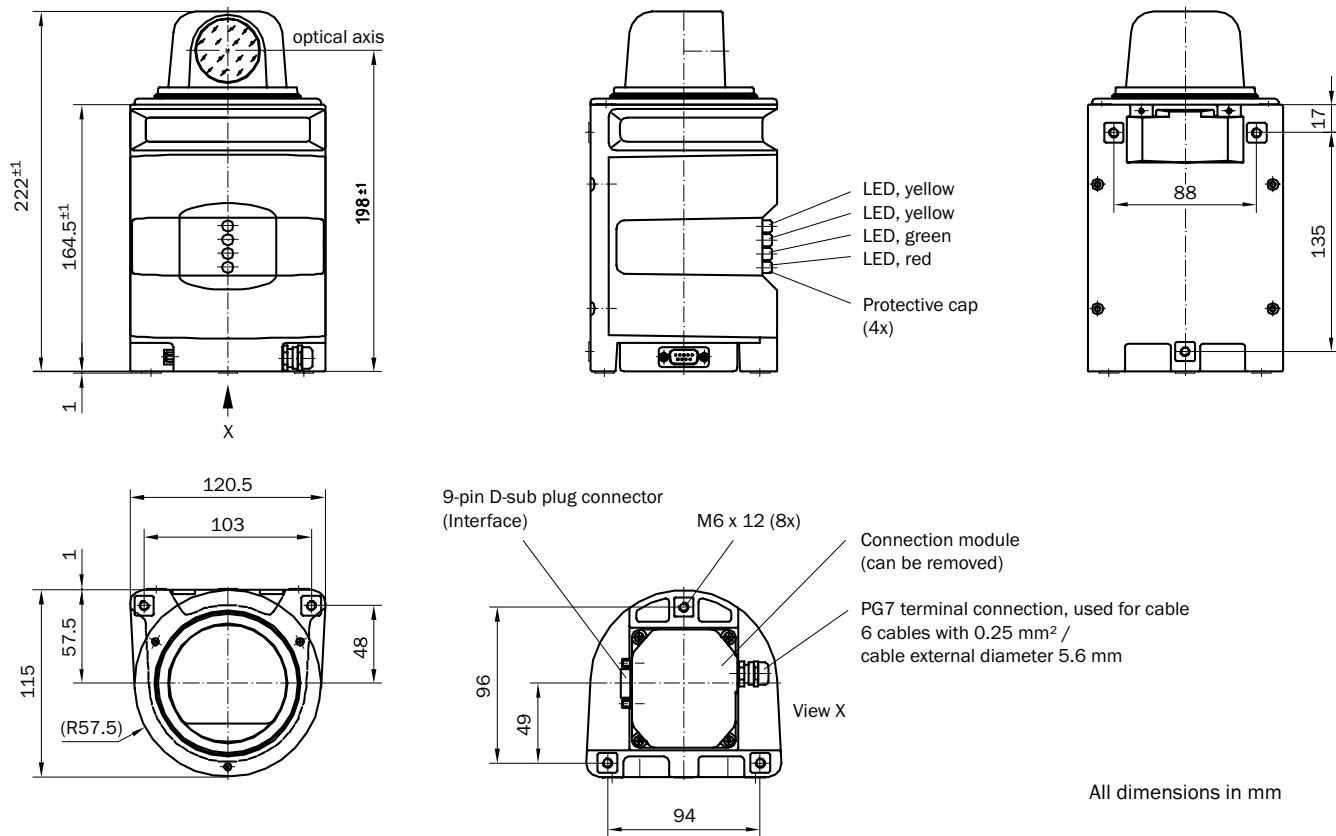

LD-LRS Outdoor

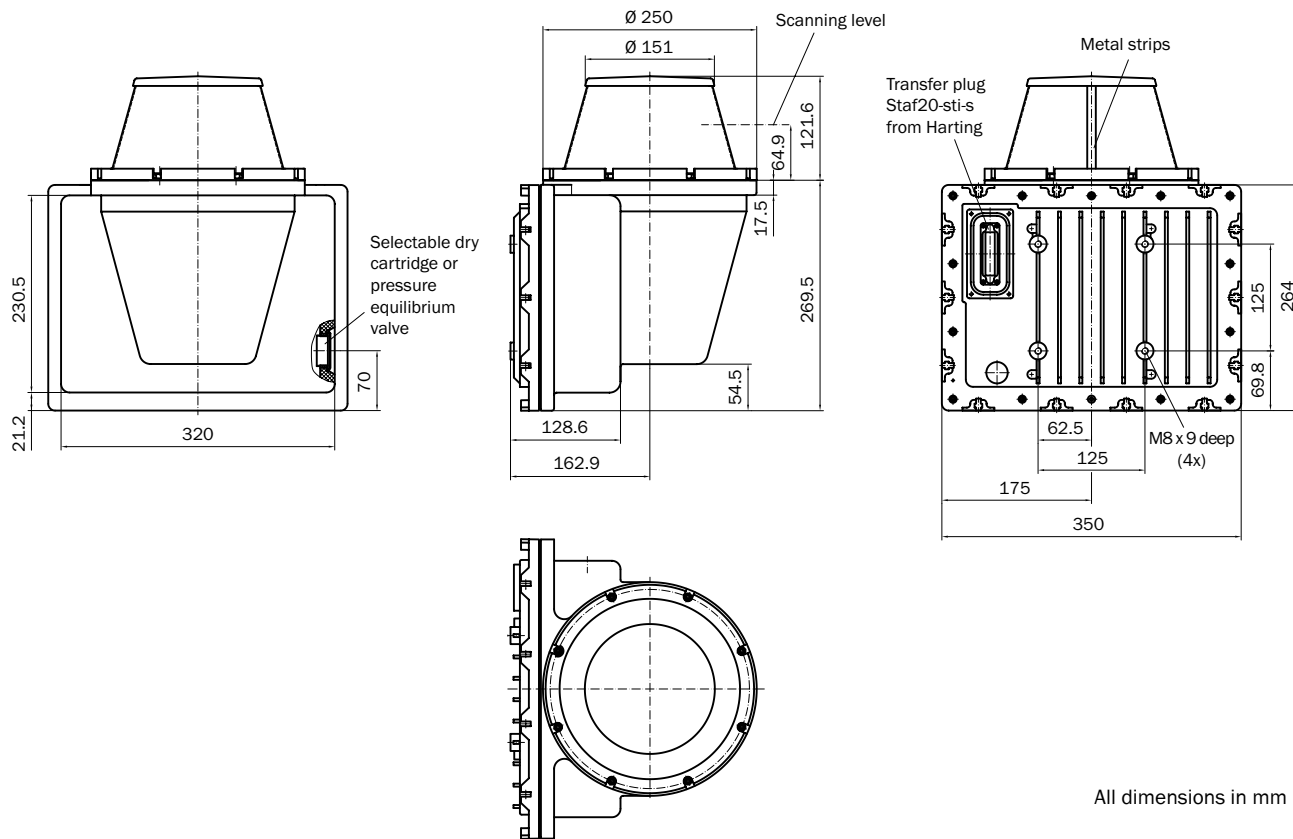

Laser measurement technology application packages

→ Additional 2D and 3D CAD models available to download free-of-charge at www.mysick.com

LMS4xx

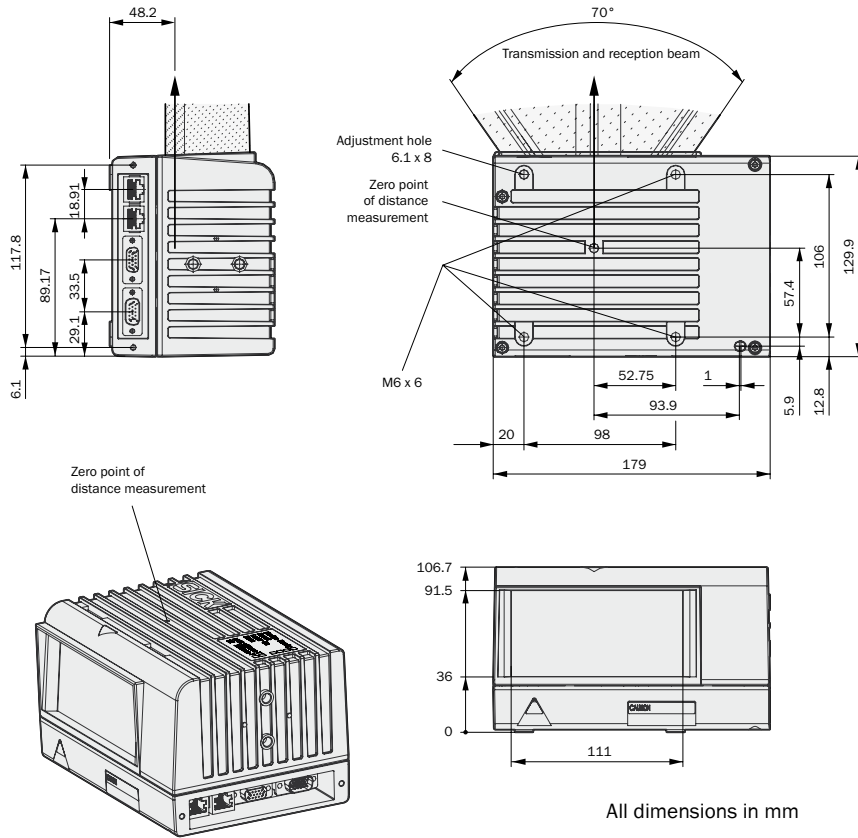

Search online quickly and safely with the SICK “Finders”

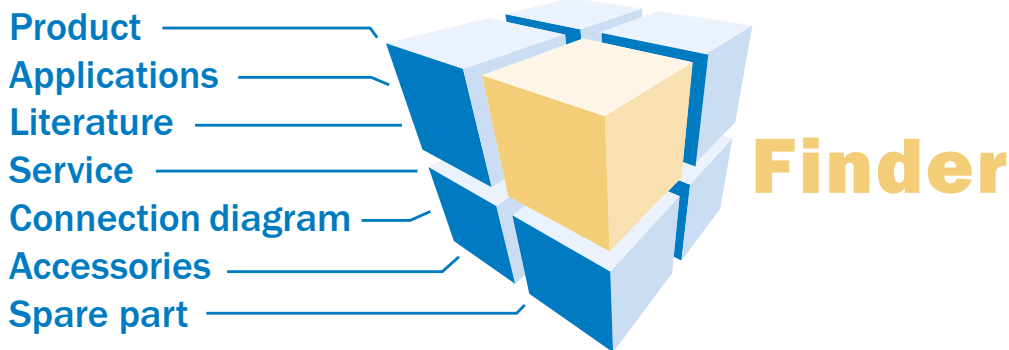

Product Finder: We can help you to quickly target the product that best matches your application.

Applications Finder: Select the application description on the basis of the challenge posed, industrial sector, or product group.

Literature Finder: Go directly to the operating instructions, technical information, and other literature on all aspects of SICK products.

These and other Finders at www.mysick.com

Efficiency – with SICK e-commerce tools

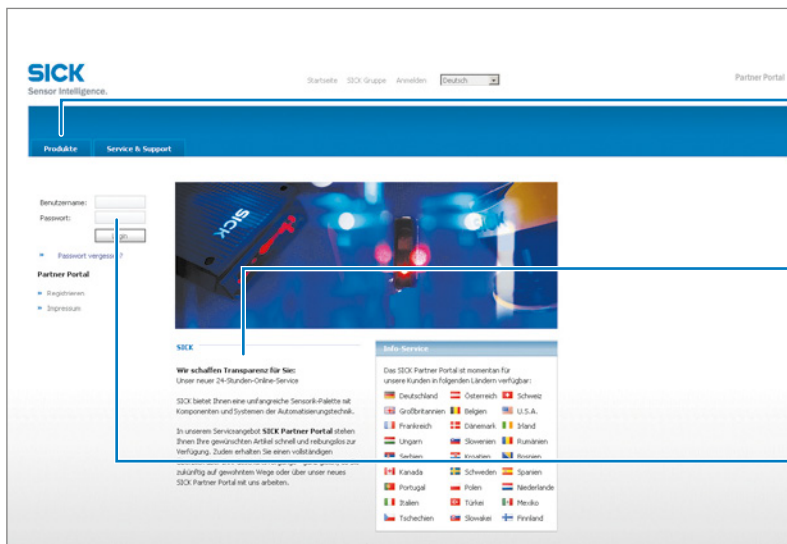

Clearly structured: You can find everything you need for your sensor planning under the menu items Products, Information, and My Account.

Available 24 hours a day: Regardless of where you are in the world or what you'd like to know – everything is just a click away at www.mysick.com.

Safe: Your data is password-protected and only visible to you. With the individual user management, you define who can see what data and who can execute what actions.

Find out prices and availability

Determine the price and possible delivery date of your desired product simply and quickly.

Order online

You can go through the ordering process in just a few steps.

Request or view a quote

You can have a quote generated online here. Every quote is confirmed to you via e-mail.

SICK at a glance

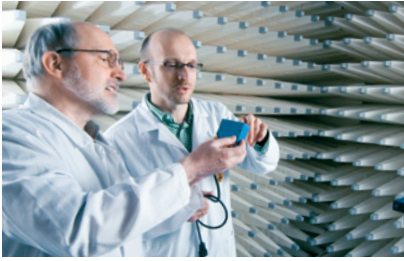

Leading technologies

With a staff of more than 5,000 and over 50 subsidiaries and representations worldwide, SICK is one of the leading and most successful manufacturers of sensor technology. The power of innovation and solution competency have made SICK the global market leader. No matter what the project and industry may be, talking with an expert from SICK will provide you with an ideal basis for your plans – there is no need to settle for anything less than the best.



Unique product range

- Non-contact detecting, counting, classifying, positioning and measuring of any type of object or media
- Accident and operator protection with sensors, safety software and services
- Automatic identification with bar code and RFID readers
- Laser measurement technology for detecting the volume, position and contour of people and objects
- Complete system solutions for analysis and flow measurement of gases and liquids



Comprehensive services

- SICK LifeTime Services – for safety and productivity
- Application centers in Europe, Asia and North America for the development of system solutions under real-world conditions
- E-Business Partner Portal www.mysick.com – price and availability of products, requests for quotation and online orders

Worldwide presence with subsidiaries in the following countries:

Australia
Belgium/Luxembourg
Brasil
Česká Republika
Canada
China
Danmark
Deutschland
España
France
Great Britain
India
Israel
Italia
Japan

México
Nederland
Norge
Österreich
Polska
România
Russia
Schweiz
Singapore
Slovenija
South Africa
South Korea
Suomi
Sverige
Taiwan
Türkiye
United Arab Emirates
USA

Please find detailed addresses and additional representatives and agencies in all major industrial nations at www.sick.com